

### FEATURES

- Best space savings in its class.
- Compact and high-capacity 30A load switching.
- Full line up (High heat-resistant type and SMD type)
- Terminals for PC board pattern designs are easily allocated.

### TYPICAL APPLICATIONS

Defogger, Seat heater, Head lamp, Fog lamp, Fan motor, etc.

## ORDERING INFORMATION

ACNM

Contact arrangement\*1

- 1: 1 Form C
- 3: 1 Form A
- 5: 1 Form C high heat-resistant type
- 7: 1 Form A high heat-resistant type

Pick-up voltage

- 1: Max. 7.2V DC

Coil voltage (DC)

- 12: 12V

Terminal shape

- Nil: PC board terminal
- SA: Surface-mount terminal

Packing style\*2

- Nil: Tube packing
- X: Tape and reel packing  
(Reverse NO terminal direction in pull-out direction)
- Z: Tape and reel packing  
(Normal NO terminal direction in pull-out direction)

Notes: \*1. Surface-mount terminal type is available in high heat-resistant type only.

- \*2. Tube packing: PC board terminal type only
- Tape and reel packing: Surface-mount type only

## TYPES

### 1. PC board terminal type

Contact arrangement	Nominal coil voltage	Part No.	
		Standard type	High heat-resistant type
1 Form A	12V DC	ACNM3112	ACNM7112
1 Form C		ACNM1112	ACNM5112

Standard packing; Carton (tube): 50 pcs.; Case: 1,500 pcs.

### 2. Surface-mount terminal type

Contact arrangement	Nominal coil voltage	Part No.	
		High heat-resistant type	
1 Form A	12V DC	ACNM7112SAX	ACNM7112SAZ
1 Form C		ACNM5112SAX	ACNM5112SAZ
		ACNM5112SAZ	

Standard packing; Carton (tape and reel): 200 pcs.; Case: 600 pcs.

Notes: \*1. Surface-mount terminal type is available in high heat-resistant type only.

\*2. An "X" at the end of the part number indicates, for tape and reel packing, reverse NO terminal direction in pull-out direction.

A "Z" at the end of the part number indicates, for tape and reel packing, normal NO terminal direction in pull-out direction.

# CN-M (ACNM)

## RATING

### 1. Coil data

Nominal coil voltage	Pick-up voltage (at 20°C 68°F)	Drop-out voltage (at 20°C 68°F)	Nominal operating current [±10%] (at 20°C 68°F)	Coil resistance [±10%] (at 20°C 68°F)	Nominal operating power (at 20°C 68°F)	Usable voltage range
12 V DC	Max. 7.2 V DC (Initial)	Min. 1.0 V DC (Initial)	53.3 mA	225Ω	640 mW	10 to 16 V DC

### 2. Specifications

Characteristics	Item	Specifications	
Contact	Arrangement	1 Form A, 1 Form C	
	Contact resistance (Initial)	Typical 5mΩ (By voltage drop 6 V DC 1 A)	
	Contact material	Ag alloy (Cadmium free)	
Rating	Nominal switching capacity (resistive load)	N.O.: 30A 14V DC, N.C.: 15A 14V DC	
	Max. carrying current (at 14V DC)	N.O. 30A/1 h, 40A/2 min. at 20°C 68°F 25A/1 h, 35A/2 min. at 85°C 185°F 20A/1 h, 30A/2 min. at 110°C 230°F (High heat-resistant type) N.C. 25A/1 h, 30A/2 min. at 20°C 68°F 20A/1 h, 25A/2 min. at 85°C 185°F 15A/1 h, 20A/2 min. at 110°C 230°F (High heat-resistant type)	
	Nominal operating power	640 mW	
	Min. switching capacity (resistive load)*	1A 12V DC	
	Insulation resistance (Initial)	Min. 100 MΩ (at 500 V DC)	
Electrical characteristics	Breakdown voltage (Initial)	Between open contacts	500 Vrms for 1 min. (Detection current: 10mA)
		Between contacts and coil	500 Vrms for 1 min. (Detection current: 10mA)
	Operate time (at nominal voltage)	Max. 10ms (at 20°C 68°F, excluding contact bounce time) (Initial)	
	Release time (at nominal voltage)	Max. 10ms (at 20°C 68°F, excluding contact bounce time) (Initial) (without diode)	
Mechanical characteristics	Shock resistance	Functional	Min. 100 m/s <sup>2</sup> {10G} (Half-wave pulse of sine wave: 11ms; detection time: 10μs)
		Destructive	Min. 1,000 m/s <sup>2</sup> {100G} (Half-wave pulse of sine wave: 6ms)
	Vibration resistance	Functional	10 Hz to 100 Hz, Min. 44.1m/s <sup>2</sup> {4.5G} (Detection time: 10μs)
		Destructive	10 Hz to 500 Hz, Min. 44.1m/s <sup>2</sup> {4.5G} Time of vibration for each direction; X, Y direction: 2 hours, Z direction: 4 hours
Expected life	Mechanical	Min. 10 <sup>7</sup> (at 120 cpm)	
		Electrical	<Resistive load> Min. 10 <sup>5</sup> (At nominal switching capacity, operating frequency: 1s ON, 2s OFF)
		<Motor load> Min. 2×10 <sup>5</sup> : at 80 A (inrush), 16 A (steady), 14 V DC (Operating frequency: 2s ON, 6s OFF)	
		<Lamp load> Min. 10 <sup>5</sup> : at 84 A (inrush), 12 A (steady), 14 V DC (Operating frequency: 1s ON, 14s OFF)	
Conditions	Conditions for operation, transport and storage	Standard type; Ambient temp: -40°C to +85°C -40°F to +185°F, Humidity: 5 to 85% R.H. High heat-resistant type; Ambient temp: -40°C to +110°C -40°F to +230°F, Humidity: 2 to 85% R.H. (Not freezing and condensing at low temperature)	
Unit weight		Approx. 5.5 g .19 oz	

Note: \*This value can change due to the switching frequency, environmental conditions, and desired reliability level, therefore it is recommended to check this with the actual load.

## REFERENCE DATA

### 1-(1). Coil temperature rise

Sample: ACNM1112, 3pcs  
Measured portion: Inside the coil  
Contact carrying current: 10A, 20A, 30A  
Ambient temperature: 26°C 78.8°F

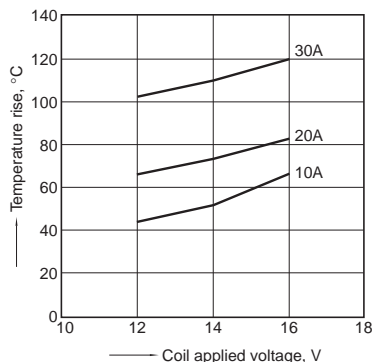

### 1-(2). Coil temperature rise

Sample: ACNM7112, 3pcs  
Measured portion: Inside the coil  
Contact carrying current: 10A, 20A  
Ambient temperature: 110°C 230°F

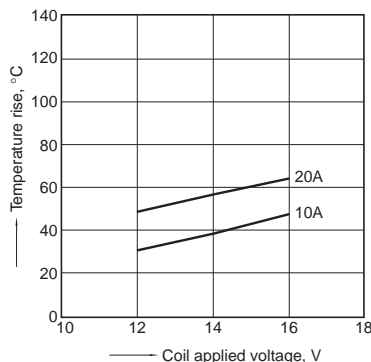

### 2. Ambient temperature and operating voltage range

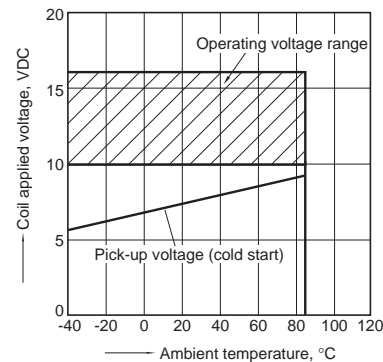

### 3. Distribution of pick-up and drop-out voltage

Sample: ACNM1112, 20pcs.

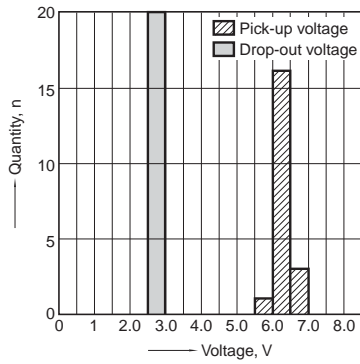

### 4. Distribution of operate and release time

Sample: ACNM1112, 20pcs.

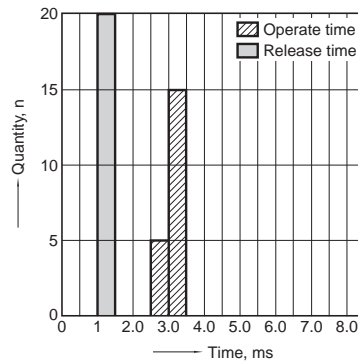

### 5-(1). Electrical life test (Resistive load)

Sample: ACNM1112, 3pcs.  
 Load: Resistive load (NO side: 30A 14V DC)  
 Operating frequency: (ON:OFF = 1s:1s)  
 Ambient temperature: Room temperature

Circuit:

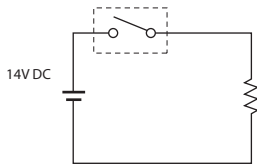

### Change of pick-up and drop-out voltage

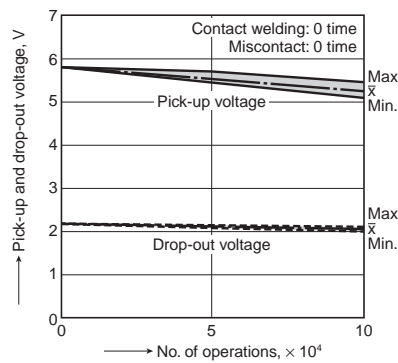

### Change of contact resistance

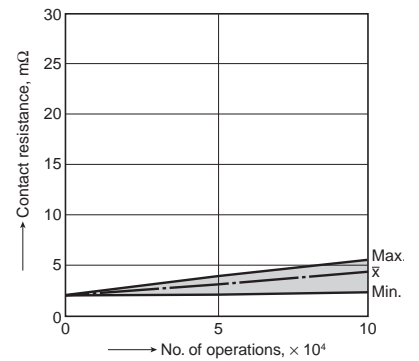

### 5-(2). Electrical life test (Motor load)

Sample: ACNM1112, 3pcs.  
 Load: inrush: 80A/steady: 16A, radiator fan actual load (motor free)  
 Switching frequency: (ON:OFF = 2s:6s)  
 Ambient temperature: 110°C 230°F

Circuit:

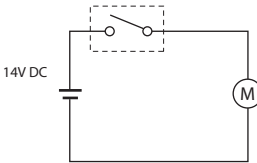

### Change of pick-up and drop-out voltage

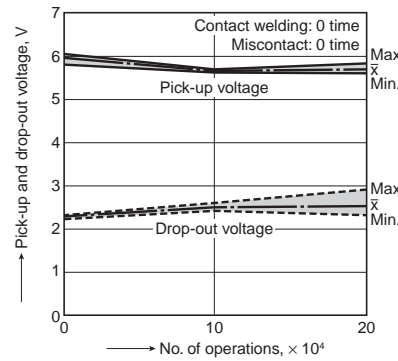

### Change of contact resistance

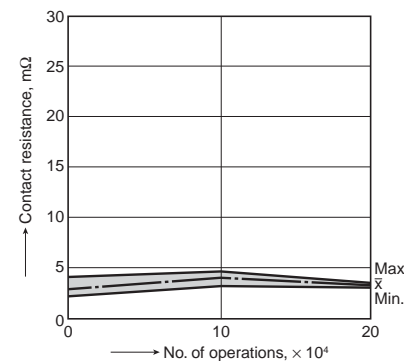

### 5-(3). Electrical life test (Lamp load)

Sample: ACNM3112, 3pcs.  
 Load: inrush: 84A/steady: 12A  
 Switching frequency: (ON:OFF = 1s:14s)  
 Ambient temperature: Room temperature

Circuit:

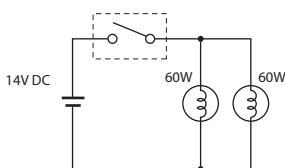

### Change of pick-up and drop-out voltage

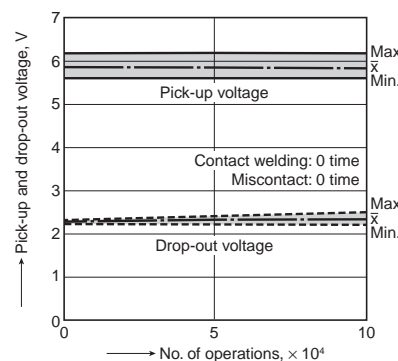

### Change of contact resistance

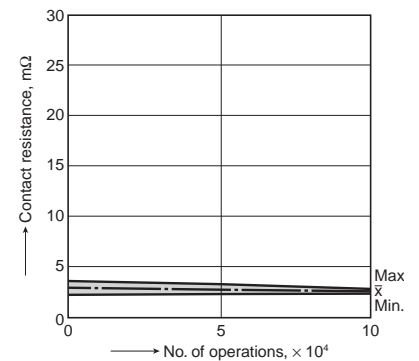

# CN-M (ACNM)

## DIMENSIONS (mm inch)

Download [CAD Data](#) from our Web site.

### 1. PC board terminal type

[CAD Data](#)



External dimensions

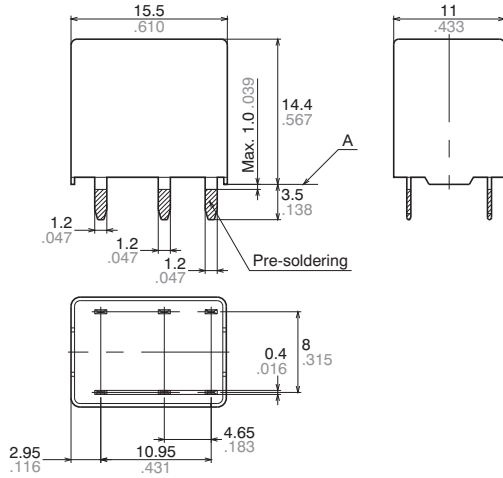

Dimension:	General tolerance
Max. 1mm .039 inch:	$\pm 0.1 \pm 0.04$
1 to 3mm .039 to .118 inch:	$\pm 0.2 \pm 0.08$
Min. 3mm .118 inch:	$\pm 0.3 \pm 0.12$

PC board pattern  
(Bottom view)

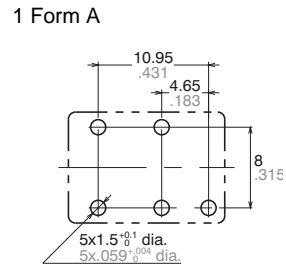

Schematic  
(Bottom view)

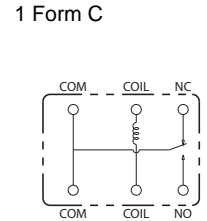
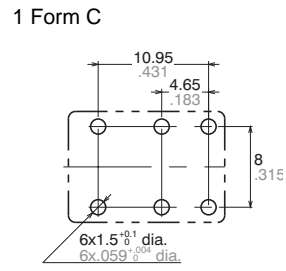
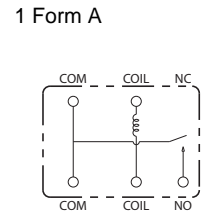

\* Dimensions (thickness and width) of terminal specified in this catalog is measured before pre-soldering.  
Intervals between terminals is measured at A surface level.

Tolerance:  $\pm 0.1 \pm 0.04$

### 2. Surface-mount terminal type

[CAD Data](#)



External dimensions

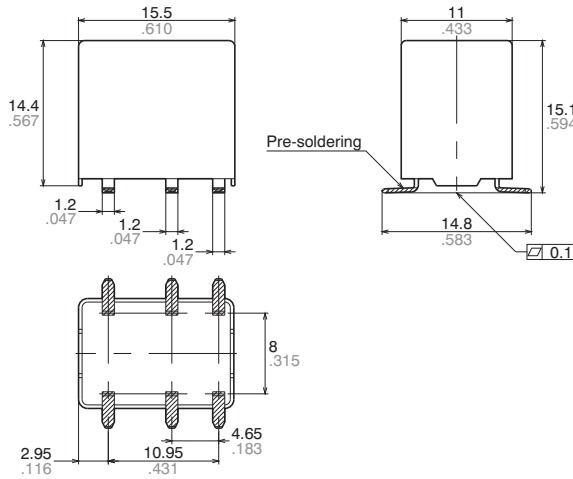

Dimension:	General tolerance
Max. 1mm .039 inch:	$\pm 0.1 \pm 0.04$
1 to 3mm .039 to .118 inch:	$\pm 0.2 \pm 0.08$
Min. 3mm .118 inch:	$\pm 0.3 \pm 0.12$

Recommended mounting pad  
(Top view)

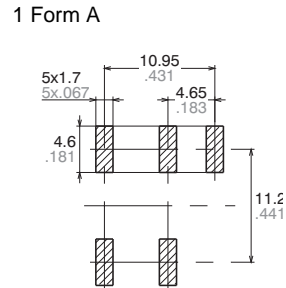

Schematic  
(Top view)

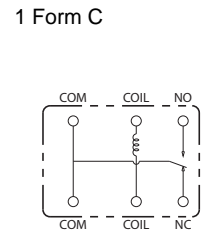
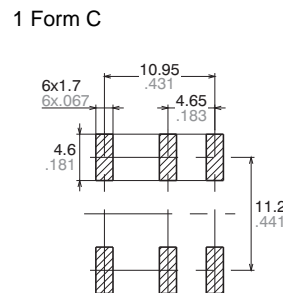
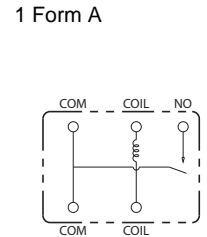

Tolerance:  $\pm 0.1 \pm 0.04$

## NOTES

### 1. Usage, transport and storage conditions

1) Ambient temperature, humidity, and atmospheric pressure during usage, transport, and storage of the relay:

(1) Temperature:

–40 to +85°C –40 to +185°F

(Standard type)

–40 to +110°C –40 to +230°F

(High heat-resistant type)

(2) Humidity: 2 to 85% RH

(Avoid freezing and condensation.)

(3) Atmospheric pressure: 86 to 106 kPa

The humidity range varies with the temperature. Use within the range indicated in the graph below.

(Temperature and humidity range for usage, transport, and storage)

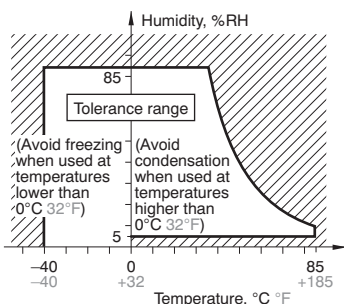
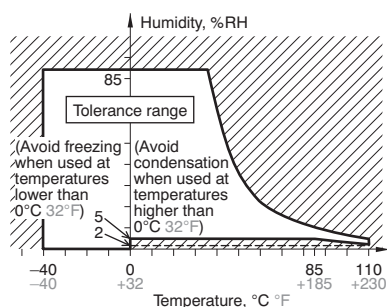

### 2. Storage condition after opening a moisture-prevention package

(1) After opening a moisture-prevention package, use the item as soon as possible (within 3 days under an environment of Max. 30°C 86°F, Max. 70% RH).

(2) If products are not used within 3 days after opening a moisture-prevention package, store them in a humidity-controlled desiccator or in a storage bag with silica gel.

### 3. Mounting and cleaning conditions for surface-mount terminal type relays

1) Recommended reflow condition is:

- Reflow-soldering temperature profile condition (IRS method)

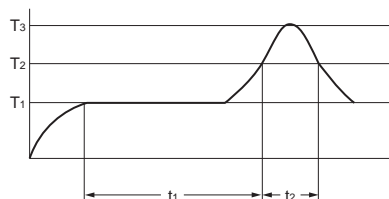

T<sub>1</sub> = 150 to 180°C 302 to 356°F  
 T<sub>2</sub> = 230°C 446°F or more  
 T<sub>3</sub> = Less than 250°C 482°F  
 t<sub>1</sub> = 60 to 120 sec.  
 t<sub>2</sub> = Less than 30 sec.

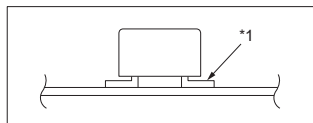

- Cautions for mounting operations  
 Temperature profile indicates the temperature of the soldered part (\*1) of terminals on the surface of a circuit board. The exterior temperature of a relay may be extremely high depending on the component density on the board or the heating method of the reflow oven or circuit board type. Sufficient verification under actual processing conditions is required.

2) Avoid cleaning (ultrasonic cleaning, boiling cleaning, etc.) and coating in order to prevent negative impacts on relay characteristics.

For Cautions for Use, see [Relay Technical Information](#).