



An Ultra-small 33 mΩ, 2.2 A pFET Integrated Power Switch with Controlled Inrush Current

General Description

Operating from a 2.5 V to 5.5 V power supply, the SLG59M1736C is a self-powered, high-performance 33 mΩ, 2.2 A single-channel pFET integrated power switch with a controlled V_{IN} inrush current profile. The SLG59M1736C's low supply current and controlled V_{IN} inrush current profile makes it an ideal pFET integrated power switch in small form-factor personal health monitor and watch applications.

Using a proprietary MOSFET design, the SLG59M1736C achieves a low $R_{DS(ON)}$ across the entire input voltage range. Through the application of Silego's proprietary CuFET technology, the SLG59M1736C's can be used in applications up to 2.2 A with a very-small 0.64 mm² WLCSP form factor.

Pin Configuration

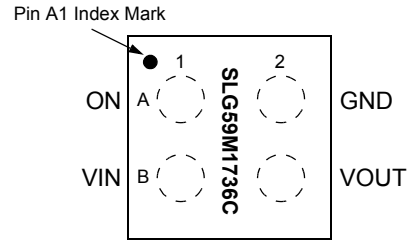

4L WLCSP
(Laser Marking View)

Features

- Integrated 2.2 A Continuous I_{DS} pFET Power Switch
- Low Typical $R_{DS(ON)}$:
 - 33 mΩ at $V_{IN} = 5.5$ V
 - 45.1 mΩ at $V_{IN} = 3.3$ V
 - 56.1 mΩ at $V_{IN} = 2.5$ V
- Input Voltage: 2.5 V to 5.5 V
- Low Typical No-load Supply Current: 0.1 μA
- Integrated VOUT Discharge Resistor
- Operating Temperature: -40 °C to 85 °C
- Low θ_{JA} , 4-pin 0.8 mm x 0.8 mm, 0.4 mm pitch 4L WLCSP Packaging
 - Pb-Free / Halogen-Free / RoHS compliant

Block Diagram

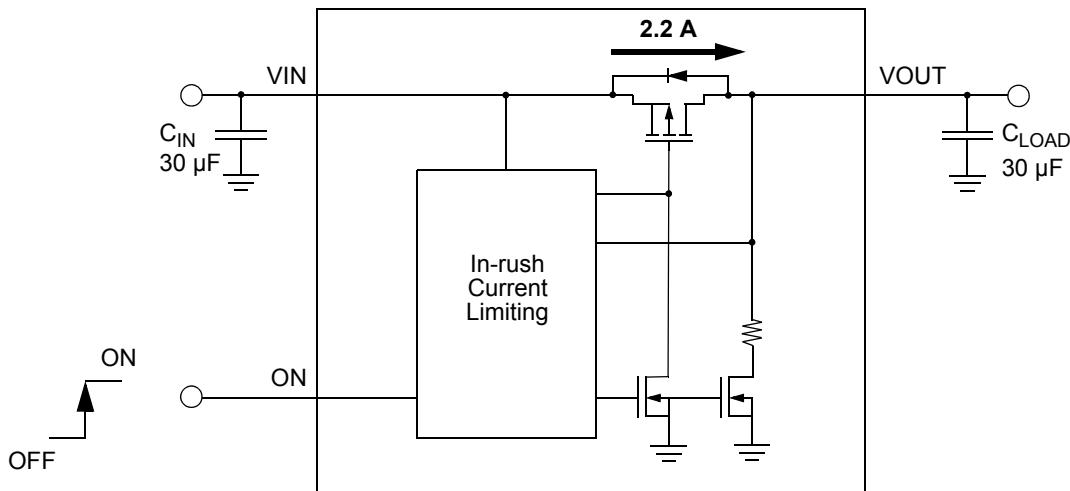



Pin Description

Pin #	Pin Name	Type	Pin Description
A1	ON	Input	A low-to-high transition on this pin initiates the operation of the SLG59M1736C. ON is an asserted HIGH, level-sensitive CMOS input with $V_{IL} < 0.3 \text{ V}$ and $V_{IH} > 0.85 \text{ V}$. As the ON pin input circuit does not have an internal pull-down resistor, connect this pin to a general-purpose output (GPO) of a microcontroller, an application processor, or a system controller – do not allow this pin to be open-circuited. In order to activate the SLG59M1736C's controlled inrush current control circuitry, ON shall be toggled HIGH only after V_{IN} is higher than the SLG59M1736C's $V_{SUCC(TH)}$ specification.
B1	VIN	MOSFET	Input terminal connection of the p-channel MOSFET. Connect a 10 μF (or larger) low-ESR capacitor from this pin to ground. Capacitors used at VIN should be rated at 10 V or higher.
B2	VOUT	MOSFET	Output terminal connection of the p-channel MOSFET. For optimal operation of the SLG59M1736C controlled inrush current profile, connect a 30 μF (or smaller) capacitor from this pin to ground. Capacitors used at VOUT should be rated at 10 V or higher.
A2	GND	GND	Ground connection. Connect this pin to system analog or power ground plane.

Ordering Information

Part Number	Type	Production Flow
SLG59M1736C	WLCSP 4L	Industrial, -40 °C to 85 °C
SLG59M1736CTR	WLCSP 4L (Tape and Reel)	Industrial, -40 °C to 85 °C



Absolute Maximum Ratings

Parameter	Description	Conditions	Min.	Typ.	Max.	Unit	
V _{IN}	Power Switch Input Voltage		--	--	6	V	
V _{OUT} to GND	Power Switch Output Voltage to GND		-0.3	--	V _{IN}	V	
ON to GND	ON Pin Voltage to GND		-0.3	--	V _{IN}	V	
T _S	Storage Temperature		-65	--	140	°C	
ESD _{HBM}	ESD Protection	Human Body Model	2000	--	--	V	
ESD _{CDM}	ESD Protection	Charged Device Model	1000	--	--	V	
MSL	Moisture Sensitivity Level		1				
θ _{JA}	Package Thermal Resistance, Junction-to-Ambient	0.8 x 0.8 mm 4L WLCSP; Determined using a 1 in ² , 2 oz .copper pad under each VIN and VOUT terminal and FR4 pcb material.	--	110	--	°C/W	
W _{DIS}	Package Power Dissipation		--	--	0.5	W	
MOSFET IDS _{PK}	Peak Current from VIN to VOUT	Maximum pulsed switch current, pulse width < 1 ms, 1% duty cycle	V _{IN} = 5.5 V	--	--	2.5	A
			V _{IN} = 2.5 V	--	--	1.5	A

Note: Stresses greater than those listed under “Absolute Maximum Ratings” may cause permanent damage to the device. This is a stress rating only and functional operation of the device at these or any other conditions above those indicated in the operational sections of this specification is not implied. Exposure to absolute maximum rating conditions for extended periods may affect reliability.

Electrical Characteristics

T_A = -40 °C to 85 °C (unless otherwise stated)

Parameter	Description	Conditions	Min.	Typ.	Max.	Unit
V _{IN}	Power Switch Input Voltage	-40 °C to 85 °C	2.5	--	5.5	V
I _{IN}	Power Switch Current (Pin B1)	When OFF, V _{IN} = 5.5 V, No load	--	0.5	2	μA
		When OFF, V _{IN} = 3.3 V, No load	--	0.06	1.5	μA
		When OFF, V _{IN} = 3.0 V, No load	--	0.06	1	μA
		When OFF, V _{IN} = 2.5 V, No load	--	0.06	1	μA
		When ON, ON = V _{IN} , No load	--	0.1	1	μA
I _{ON_LKG}	ON Pin Input Leakage		--	--	0.1	μA
RDS _{ON}	ON Resistance @ T _A 25°C	@ 5.5 V, I _{DS} = 100 mA	--	33	41	mΩ
		@ 3.3 V, I _{DS} = 100 mA	--	45.1	55	mΩ
		@ 2.5 V, I _{DS} = 100 mA	--	56.1	69	mΩ
RDS _{ON}	ON Resistance @ T _A 85°C	@ 5.5 V, I _{DS} = 100 mA	--	40.2	49	mΩ
		@ 3.3 V, I _{DS} = 100 mA	--	54.5	66	mΩ
		@ 2.5 V, I _{DS} = 100 mA	--	68.2	82	mΩ
MOSFET IDS	Current from VIN to VOUT	Continuous, V _{IN} = 5 V	--	--	2.2	A
		Continuous, V _{IN} = 2.5 V	--	--	1.2	A
V _{SUCC(TH)}	V _{IN} Inrush Current Start-up Control Threshold Voltage	ON ≥ V _{ON_VIH} ; See Timing Diagram on Page 4 and Note 1	--	0.9 x V _{IN}	--	V
I _{RISE}	Rise Time Charging Current	10% V _{OUT} to 90% V _{OUT} ↑; V _{IN} = 5.0 V, C _{LOAD} = 30 μF, See Note 1	11	16.5	25	mA
V _{OUT(SR)}	Slew Rate	10% V _{OUT} to 90% V _{OUT} ↑; V _{IN} = 5.0 V, C _{LOAD} = 30 μF	0.36	0.54	0.8	V/ms



Electrical Characteristics (continued)

T_A = -40 °C to 85 °C (unless otherwise stated)

Parameter	Description	Conditions	Min.	Typ.	Max.	Unit
T _{RISE}	Rise Time	10% V _{OUT} to 90% V _{OUT} ↑ V _{IN} = 5.0 V, C _{LOAD} = 30 μF, no R _{LOAD}	5	7.6	11	ms
		10% V _{OUT} to 90% V _{OUT} ↑ V _{IN} = 2.5 V, C _{LOAD} = 30 μF, no R _{LOAD}	2.5	3.8	5.5	ms
T _{Total_ON}	Total Turn On Time	V _{ON_VIH} to 90% V _{OUT} ↑ V _{IN} = 5 V, C _{LOAD} = 30 μF, No R _{LOAD}	6	8.6	12	ms
		V _{ON_VIH} to 90% V _{OUT} ↑ V _{IN} = 2.5 V, C _{LOAD} = 30 μF, No R _{LOAD}	3	4.3	6	ms
T _{OFF_Delay}	OFF Delay Time	V _{ON_VIL} to V _{OUT} Fall, V _{IN} = 5 V, R _{LOAD} =10 Ω, no C _{LOAD}	--	4.5	--	μs
C _{LOAD}	Output Load Capacitance	C _{LOAD} connected from V _{OUT} to GND	--	--	30	μF
R _{DIS}	Discharge Resistance	V _{IN} = 2.5 V to 5.5 V, V _{OUT} = 0.4 V Input Bias	53	90	150	Ω
ON_V _{IH}	Initial Turn On Voltage		0.85	--	V _{IN}	V
ON_V _{IL}	Low Input Voltage on ON pin		-0.3	0	0.3	V

Notes:

1. Rise of ON pin must only occur after V_{IN} reaches V_{SUCC(TH)} in order to have proper in-rush current limiting and start-up.

T_{Total_ON}, T_{ON_Delay} and Slew Rate Measurement

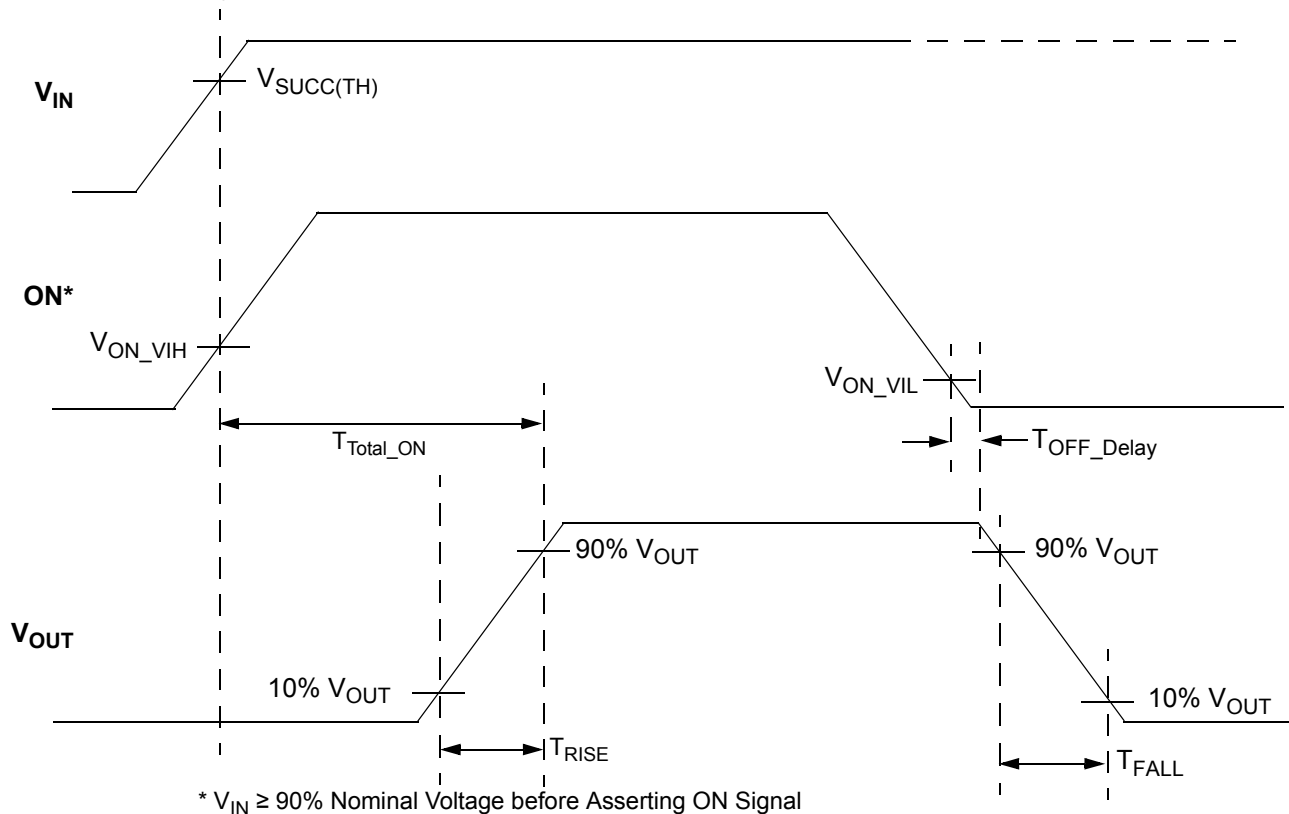



RDS_{ON} vs. Temperature and V_{IN}

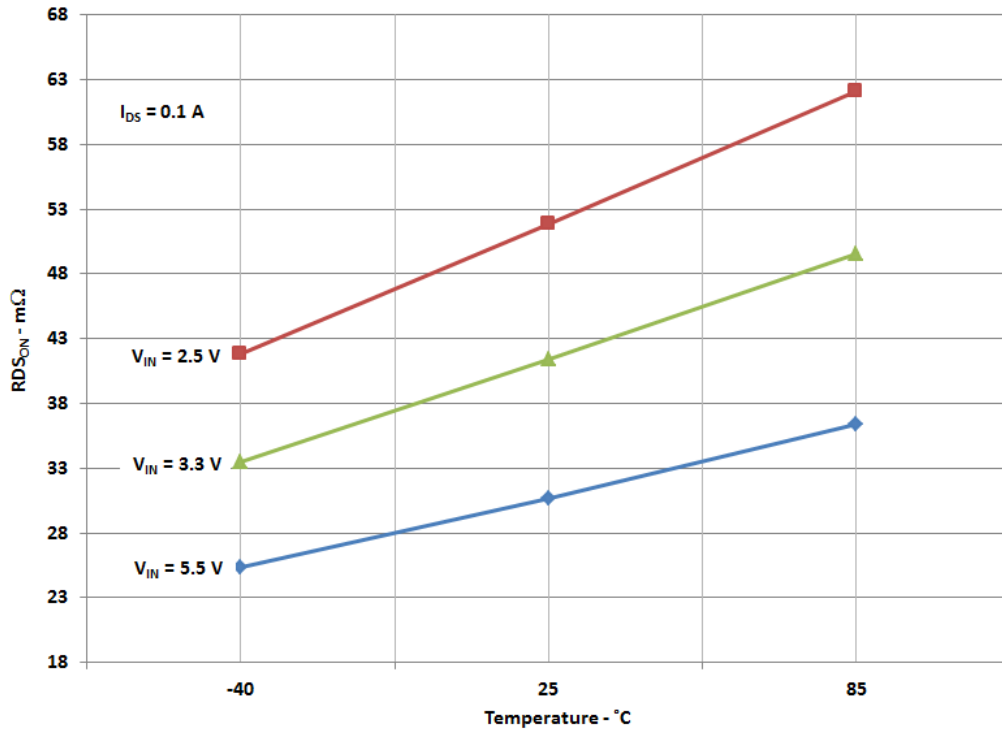

T_{RISE} vs. C_{LOAD}, Temperature, and V_{IN}

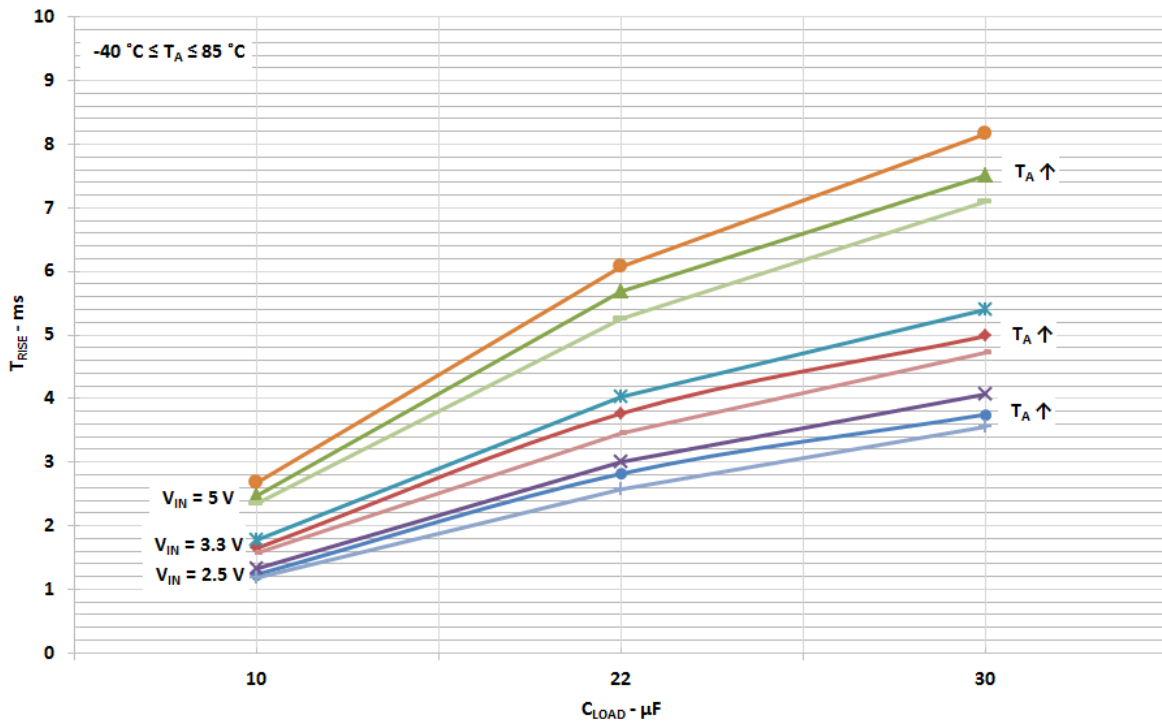



T_{Total_ON} vs. C_{LOAD} , Temperature, and V_{IN}

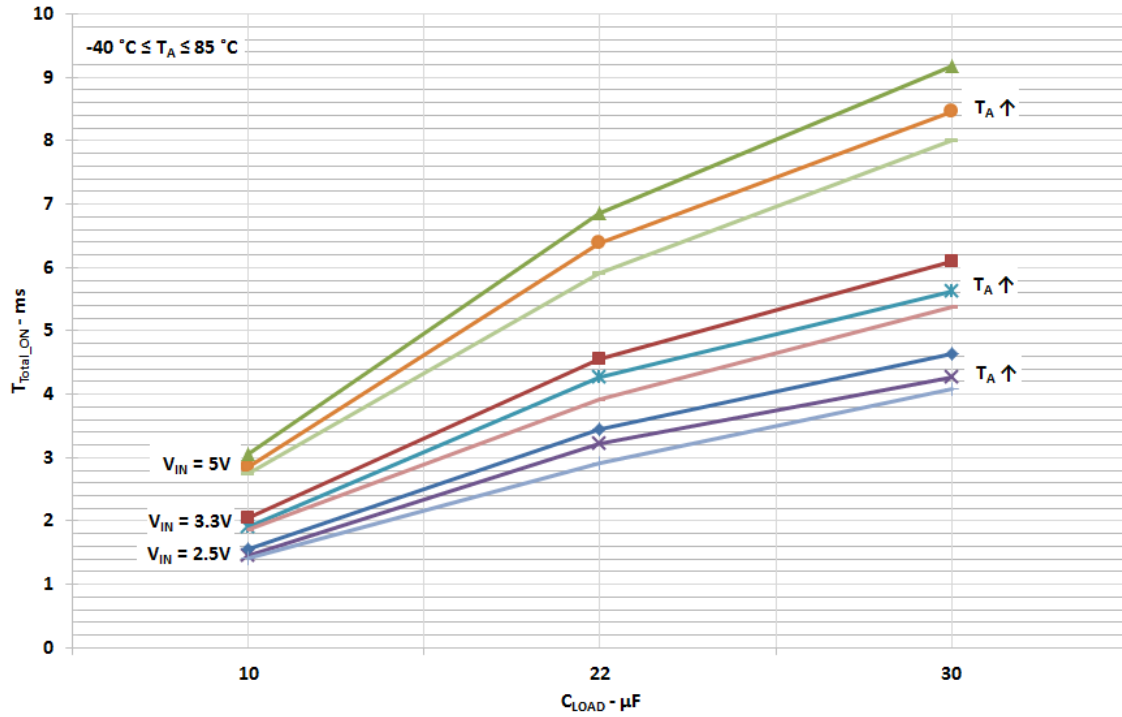

V_{IN} vs. Max I_{DS} , Safe Operation Area

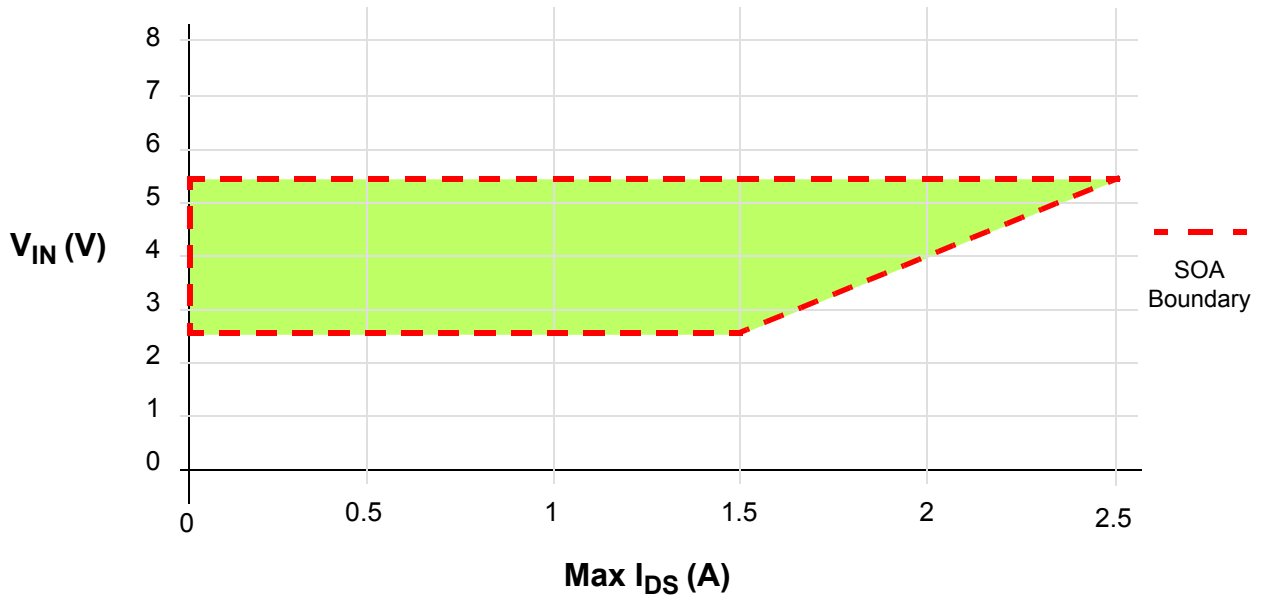



Typical Turn-on Waveforms

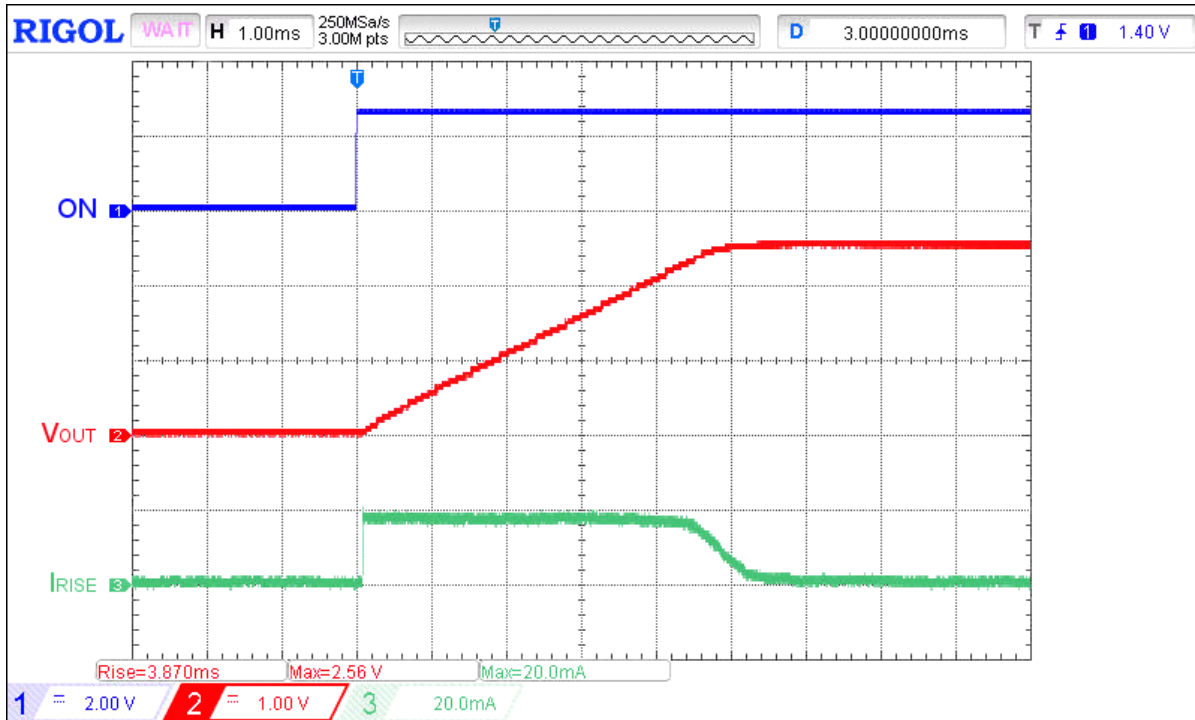

Figure 1. Typical Turn ON operation waveform for $V_{IN} = 2.5\text{ V}$, $C_{LOAD} = 30\ \mu\text{F}$

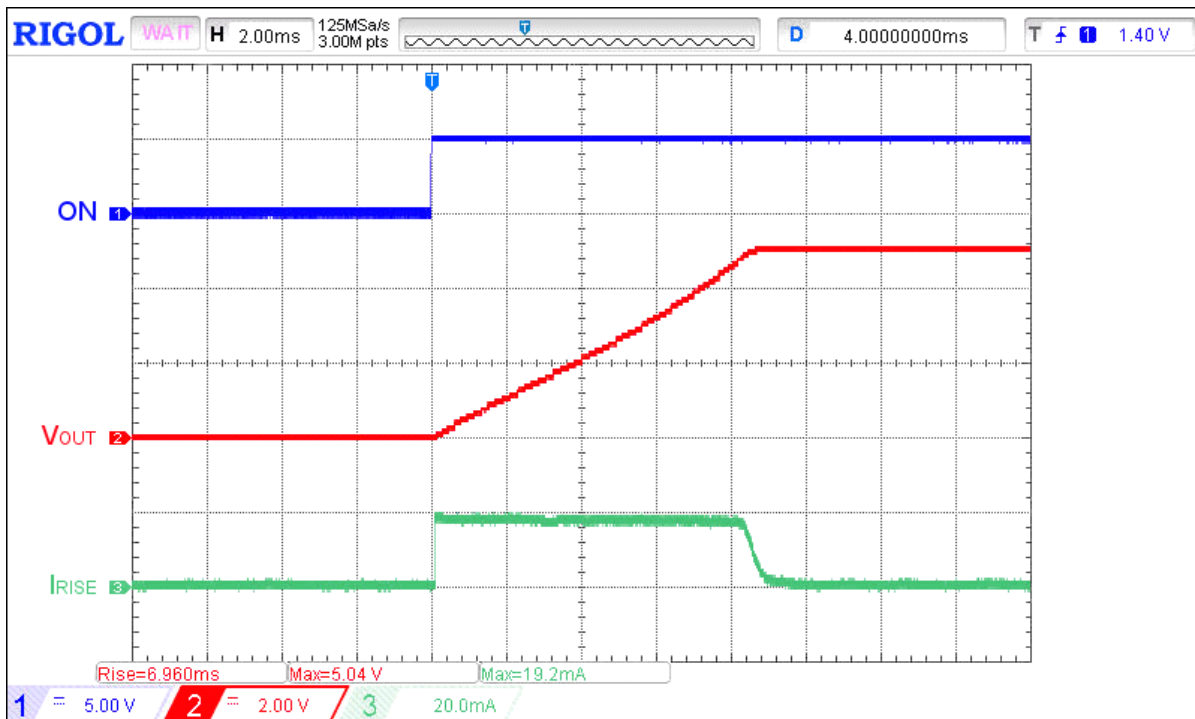

Figure 2. Typical Turn ON operation waveform for $V_{IN} = 5\text{ V}$, $C_{LOAD} = 30\ \mu\text{F}$



Typical Turn-off Waveforms

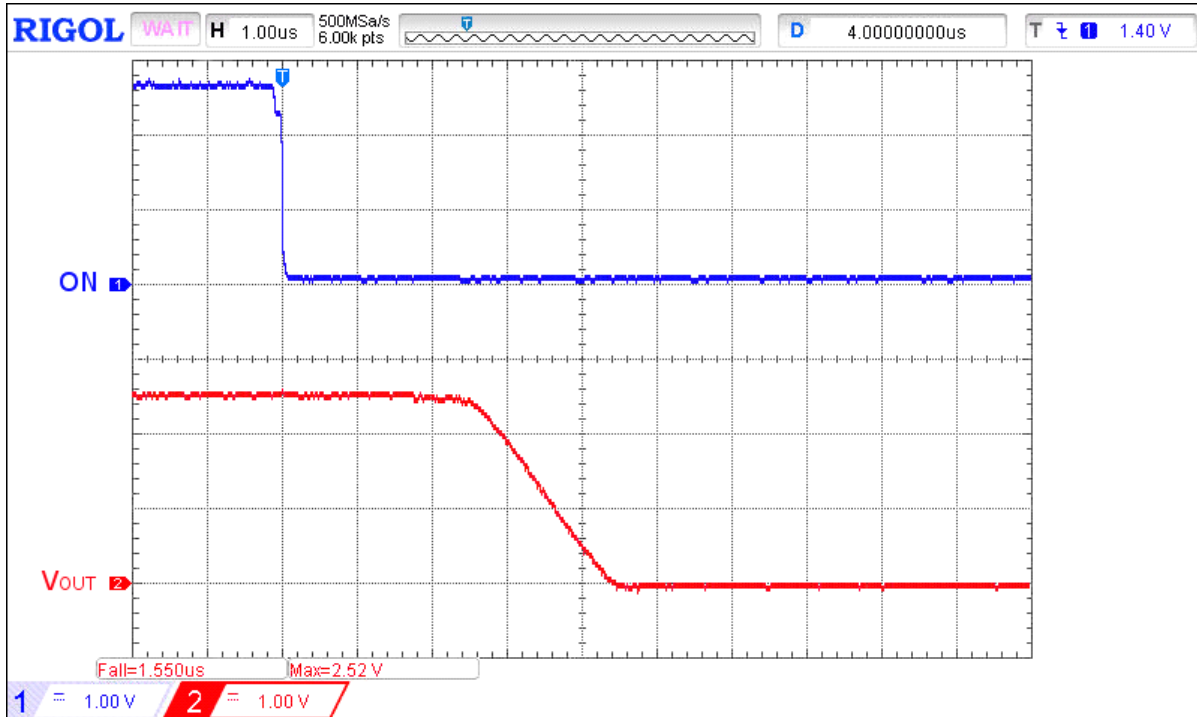

Figure 3. Typical Turn OFF operation waveform for $V_{IN} = 2.5 \text{ V}$, no C_{LOAD} , $R_{LOAD} = 10 \Omega$

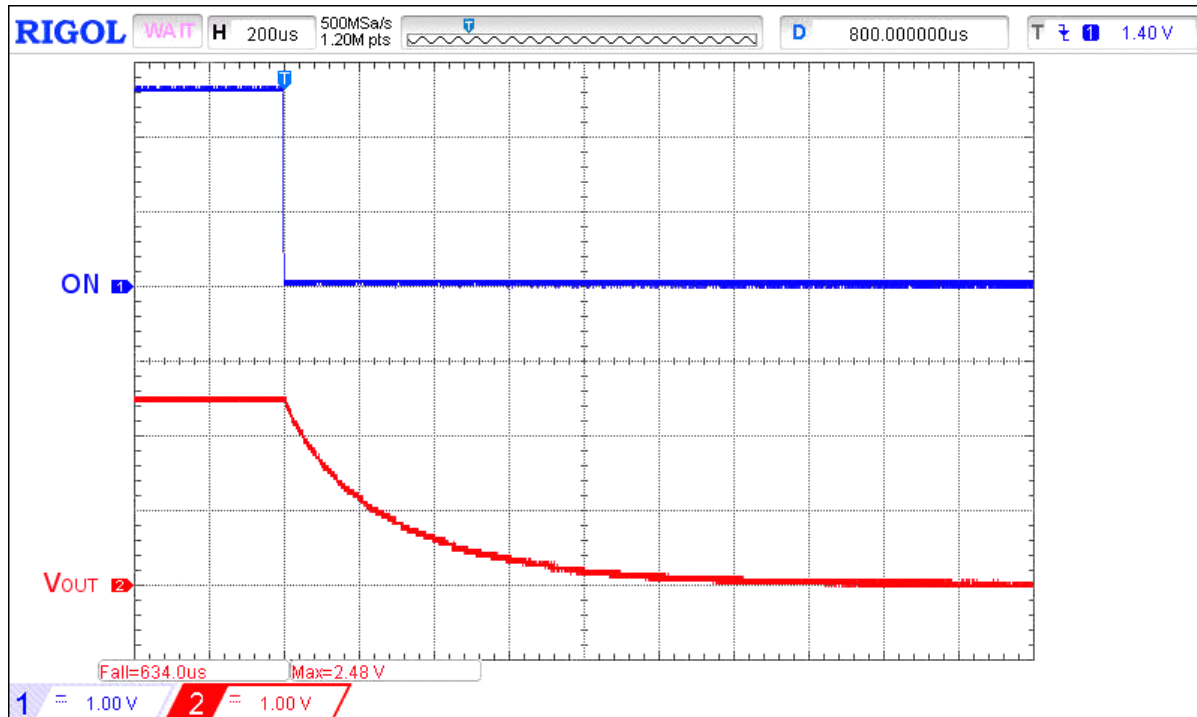

Figure 4. Typical Turn OFF operation waveform for $V_{IN} = 2.5 \text{ V}$, $C_{LOAD} = 30 \mu\text{F}$, $R_{LOAD} = 10 \Omega$

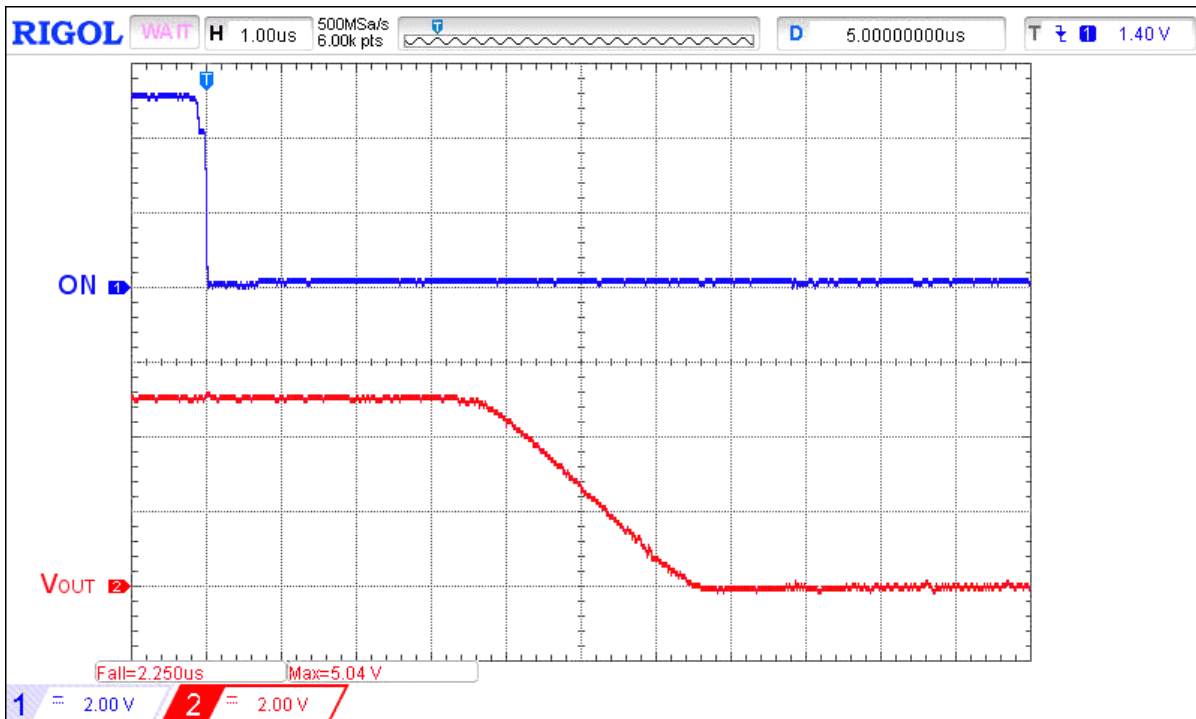

Figure 5. Typical Turn OFF operation waveform for $V_{IN} = 5\text{ V}$, no C_{LOAD} , $R_{LOAD} = 10\ \Omega$

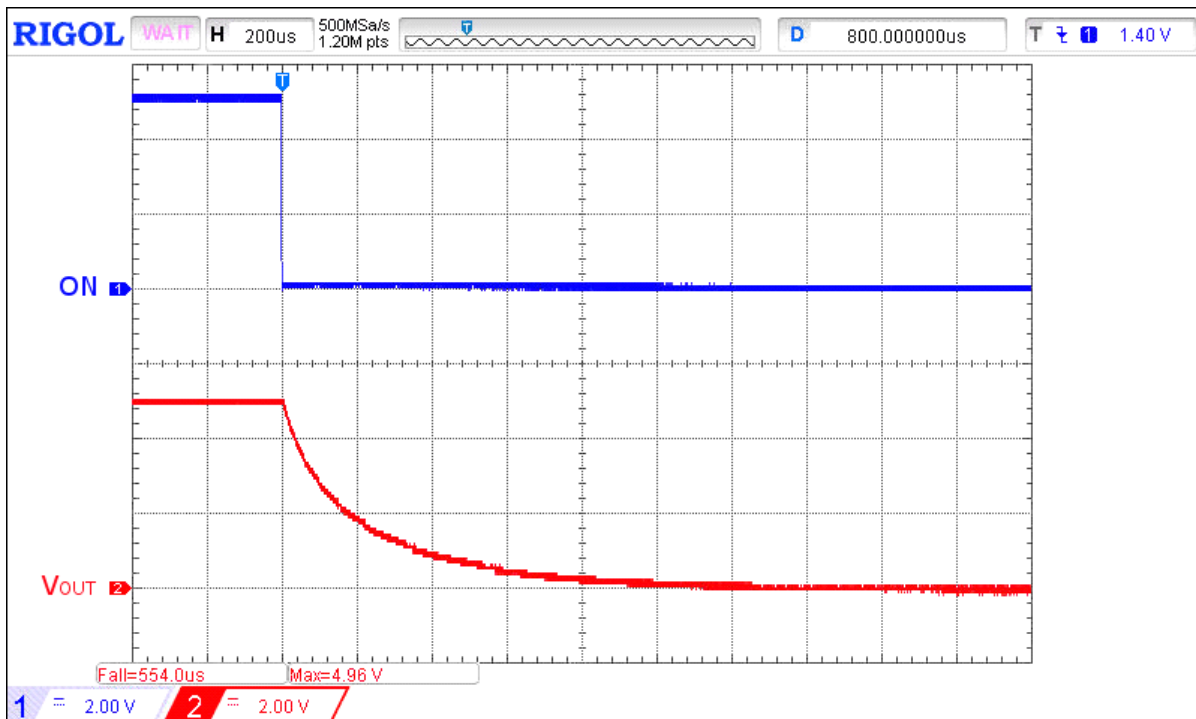

Figure 6. Typical Turn OFF operation waveform for $V_{IN} = 5\text{ V}$, $C_{LOAD} = 30\ \mu\text{F}$, $R_{LOAD} = 10\ \Omega$



Applications Information

SLG59M1736C Nominal Operation

During V_{IN} power-up operation, the SLG59M1736C's internal inrush current Start-up Control circuit is activated once V_{IN} reaches 90% of its nominal voltage (Please see $V_{SUCC(TH)}$ specification). Once V_{IN} has reached this threshold (within the SLG59M1736C's nominal input range of 2.5 V to 5.5 V), the ON pin can be toggled LOW-to-HIGH to close the switch. Nominal power-off sequence is performed in reverse: that is, the ON pin is toggled HIGH-to-LOW to open the switch before V_{IN} is powered down/turned OFF.

SLG59M1736C VIN Inrush Current Limit on Startup

During startup, the current passing through the power FET is internally limited to a maximum specified by I_{RISE} in the EC table. To prevent incomplete start-up, the SLG59M1736C shall be powered up only with a capacitive load C_{LOAD} attached to the VOUT pin. After V_{OUT} ramps up to its nominal voltage, a resistive load (R_{LOAD}) can be applied to the integrated power switch.

Slew Rate Calculation

During the rise of V_{OUT} , the SLG59M1736C limits the output current to I_{RISE} . With a capacitor C_{LOAD} attached to VOUT, the equation below provides the nominal value for the slew rate:

$$\text{Slew Rate} = \frac{I_{RISE}}{C_{LOAD}}$$

Power Dissipation Considerations

The junction temperature of the SLG59M1736C depends on factors such as board layout, ambient temperature, external air flow over the package, load current, and the $R_{DS(ON)}$ -generated voltage drop across each power MOSFET. While the primary contributor to the increase in the junction temperature of the SLG59M1736C is the power dissipation of its power MOSFETs, its power dissipation and the junction temperature in nominal operating mode can be calculated using the following equations:

$$PD_{TOTAL} = R_{DS(ON)} \times I_{DS}^2$$

where:

PD_{TOTAL} = Total package power dissipation, in Watts (W)

$R_{DS(ON)}$ = Power MOSFET ON resistance, in Ohms (Ω)

I_{DS} = Output current, in Amps (A)

and

$$T_J = PD_{TOTAL} \times \Theta_{JA} + T_A$$

where:

T_J = Die junction temperature, in Celsius degrees ($^{\circ}C$)

Θ_{JA} = Package thermal resistance, in Celsius degrees per Watt ($^{\circ}C/W$) – highly dependent on pcb layout

T_A = Ambient temperature, in Celsius degrees ($^{\circ}C$)

In nominal operating mode, the SLG59M1736C's power dissipation can also be calculated by taking into account the voltage drop across the switch ($V_{IN} - V_{OUT}$) and the magnitude of the switch's output current (I_{DS}):

$$PD_{TOTAL} = (V_{IN} - V_{OUT}) \times I_{DS} \text{ or}$$

$$PD_{TOTAL} = (V_{IN} - (R_{LOAD} \times I_{DS})) \times I_{DS}$$

where:

PD_{TOTAL} = Total package power dissipation, in Watts (W)

V_{IN} = Switch input Voltage, in Volts (V)

R_{LOAD} = Output Load Resistance, in Ohms (Ω)

I_{DS} = Switch output current, in Amps (A)

V_{OUT} = Switch output voltage, or $R_{LOAD} \times I_{DS}$



Package Top Marking System Definition

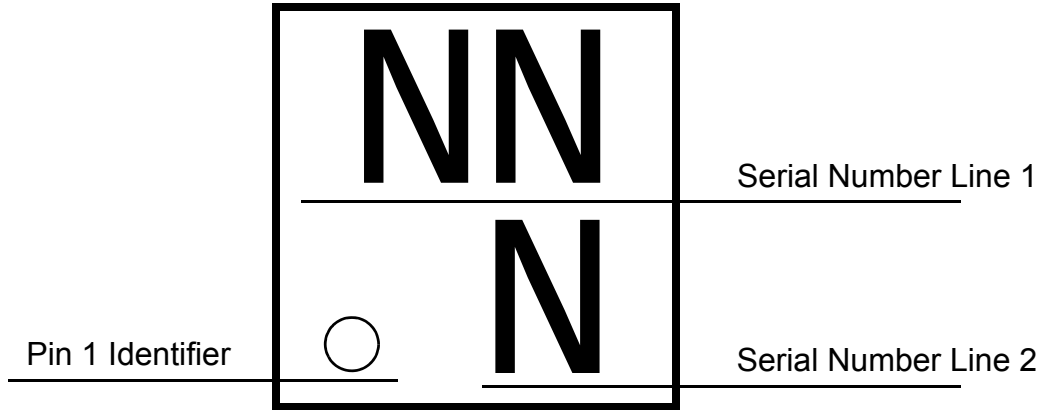

NN -Part Serial Number Field Line 1
where each "N" character can be A-Z and 0-9
N -Part Serial Number Field Line 2
where each "N" character can be A-Z and 0-9



Package Drawing and Dimensions

4 Pin WLCSP Green Package 0.8 x 0.8 mm

Laser Marking View

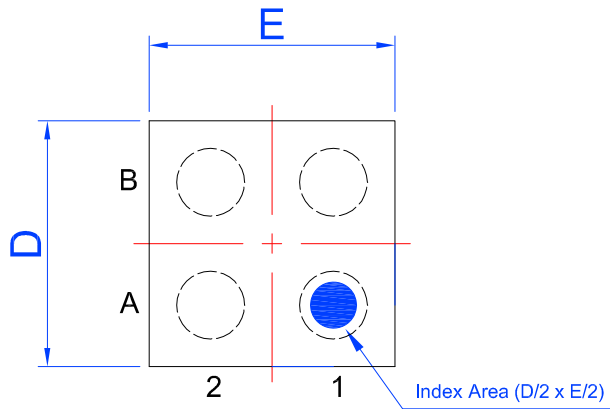

Bump View

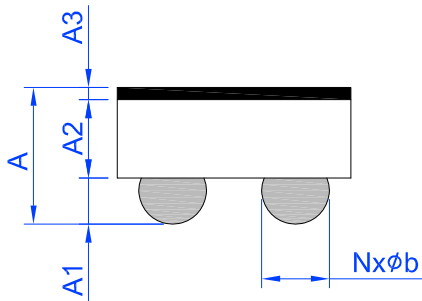
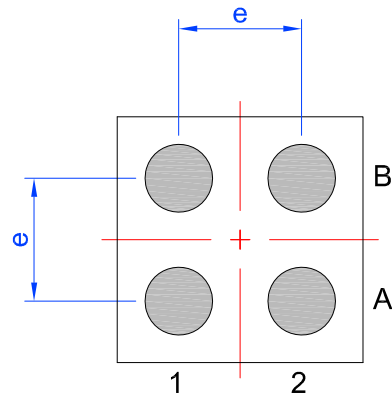

SIDE View

TERMINALS ASSIGNMENTS		
B	VIN	VOUT
A	ON	GND
	1	2

Unit: mm

Symbol	Min	Nom.	Max	Symbol	Min	Nom.	Max
A	0.380	-	0.500	D	0.77	0.80	0.83
A1	0.125	0.150	0.175	E	0.77	0.80	0.83
A2	0.240	0.265	0.290	e	0.40 BSC		
A3	0.015	0.025	0.035	N	4 (Bump)		
b	0.195	0.220	0.245				



SLG59M1736C 4 Pin WLCSP PCB Landing Pattern

 Exposed Bump
(Laser marking view)

 Recommended
Land Pattern

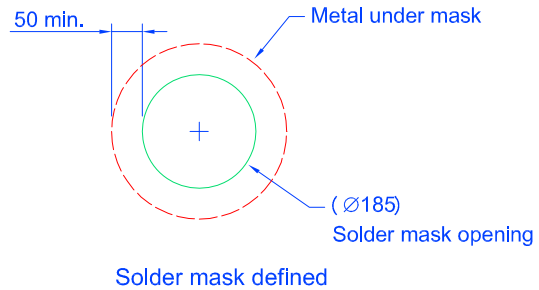
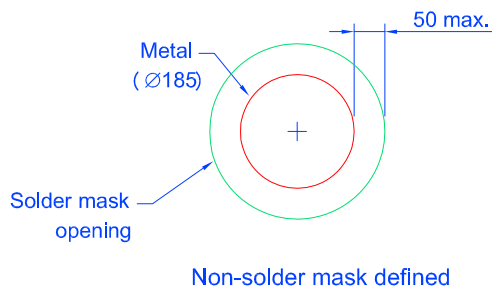
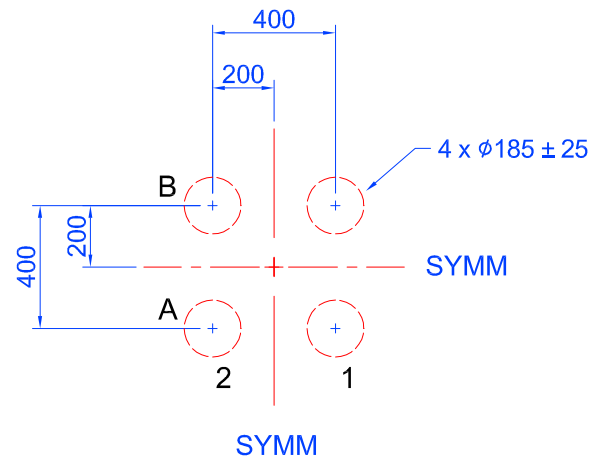
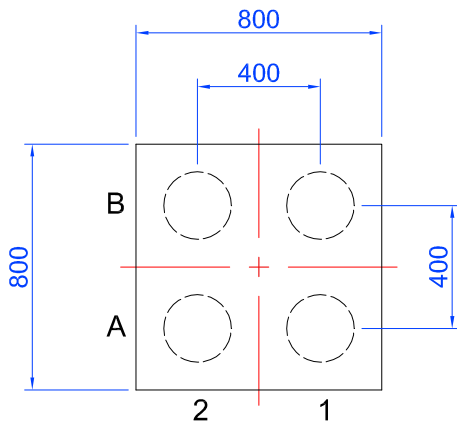

Solder mask detail (not to scale)

Unit: um



Recommended Reflow Soldering Profile

For successful reflow of the SLG59M1736C a recommended thermal profile is illustrated below:

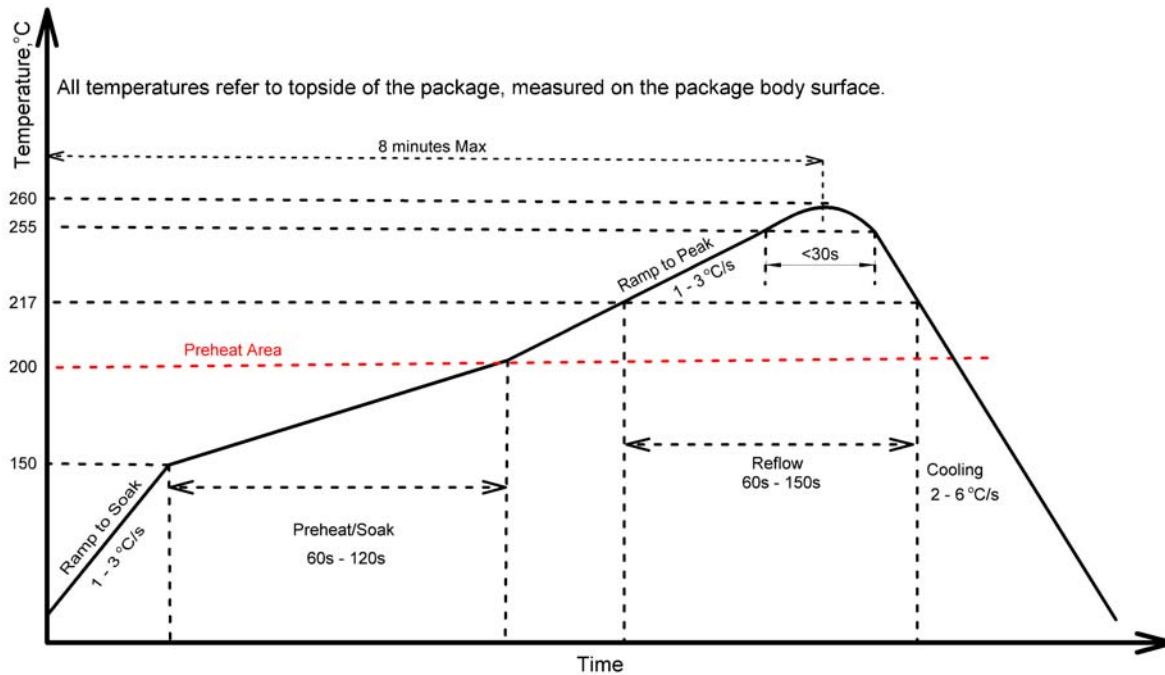

Note: This reflow profile is for classification/preconditioning and are not meant to specify board assembly profile. Actual board assembly profiles should be developed based on specific process needs and board designs and should not exceed parameters depicted on figure above.

Please see more information on IPC/JEDEC J-STD-020: latest revision for reflow profile based on package volume of 0.352 mm³ (nominal).



Tape and Reel Specifications

Package Type	# of Pins	Nominal Package Size [mm]	Max Units		Reel & Hub Size [mm]	Leader (min)		Trailer (min)		Tape Width [mm]	Part Pitch [mm]
			per Reel	per Box		Pockets	Length [mm]	Pockets	Length [mm]		
WLCSP4L 0.8 x 0.8 mm 0.4P Green	4	0.8 x 0.8 x 0.44	3000	3000	178/60	100	400	100	400	8	4

Carrier Tape Drawing and Dimensions

Package Type	Pocket BTM Length	Pocket BTM Width	Pocket Depth	Index Hole Pitch	Pocket Pitch	Index Hole Diameter	Index Hole to Tape Edge	Index Hole to Pocket Center	Tape Width	Tape Thickness
	A0	B0	K0	P0	P1	D0	E	F	W	T
WLCSP 4L 0.8x0.8mm 0.4P Green	0.87	0.87	0.56	4	2	1.5	1.75	3.5	8	0.2

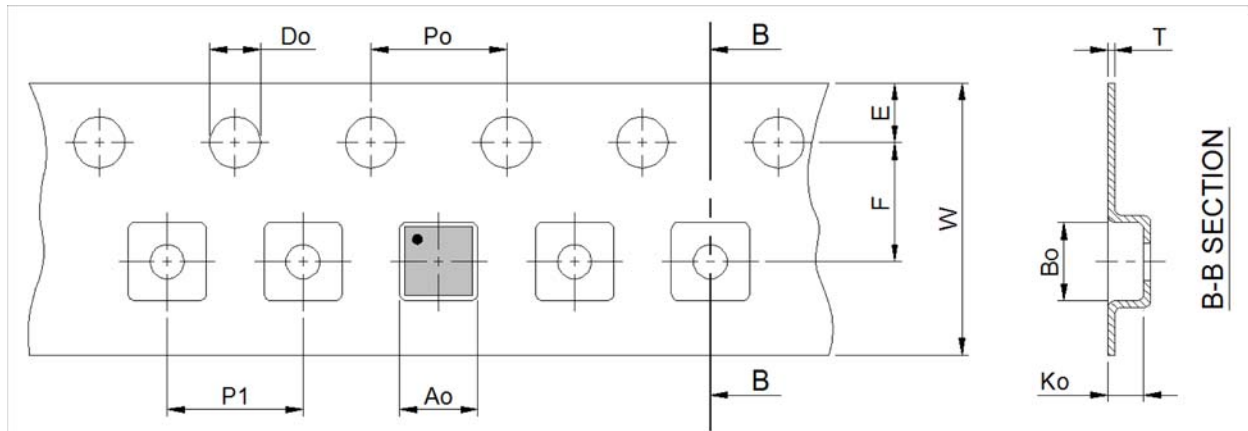

Note: 1.Orientation in carrier: Pin1 is at upper left corner (Quadrant 1).

Refer to EIA-481 specification



Revision History

Date	Version	Change
7/24/2017	1.03	Updated Tape and Reel Specification
5/5/2017	1.02	Updated EC Table
3/28/2017	1.01	Fixed typos Updated PCB Landing Pattern
3/1/2017	1.00	Production Release