

## 26 GHz, DIVIDE-BY-8 WITH RESET & PROGRAMMABLE OUTPUT VOLTAGE

### Typical Applications

The HMC859LC3 is ideal for:

- High Speed Frequency Divider (up to 26 GHz)
- Clock Synthesis
- Phase Locked Loops
- Broadband Test & Measurement

### Features

- Supports Clock Frequencies up to 26 GHz
- Differential or Single-Ended Operation
- Fast Rise and Fall Times: 19 / 17 ps
- Low Power Consumption: 320 mW typ.
- Programmable Differential Output Voltage Swing: 800 - 1900 mVp-p
- Propagation Delay: 146 ps
- Single Supply: -3.3 V
- 16 Lead Ceramic 3x3 mm SMT Package: 9 mm<sup>2</sup>

### Functional Diagram

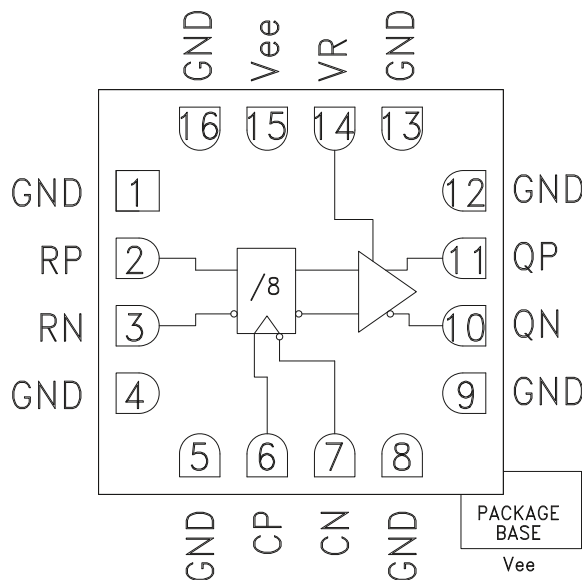

### General Description

The HMC859LC3 is a Divide-by-8 w/Reset designed to support clock frequencies as high as 26 GHz. During normal operation, with the reset pin not asserted, the output toggles from its prior state on the positive edge of the clock. Asserting the reset pin forces the Q output low regardless of the clock edge state (asynchronous reset assertion). Reversing the clock inputs allows for negative-edge triggered applications.

All differential inputs to the HMC859LC3 are CML and terminated on-chip with 50 Ohms to the positive supply, GND, and may be DC or AC coupled. Outputs can be connected directly to a 50 Ohm ground-terminated system or drive devices with CML logic input. The HMC859LC3 also features an output level control pin, VR, which allows for loss compensation or signal level optimization. The HMC859LC3 operates from a single -3.3 V supply and is available in ROHS-compliant 3x3 mm SMT package.

### Electrical Specifications, $T_A = +25\text{ }^\circ\text{C}$ , $V_{ee} = -3.3\text{ V}$ , $VR = 0\text{ V}$

Parameter	Conditions	Min.	Typ.	Max	Units
Power Supply Voltage		-3.6	-3.3	-3.0	V
Power Supply Current			97		mA
Maximum Clock Rate			26		GHz
Input Voltage Range		-1.5		0.5	V
Input Differential Range		0.1		2.0	Vp-p
Input Return Loss	Frequency <25 GHz		10		dB
Output Amplitude	Single-Ended, peak-to-peak		825		mVp-p
	Differential, peak-to-peak		1650		mVp-p
Output High Voltage			-15		mV
Output Low Voltage			-840		mV

# HMC859\* PRODUCT PAGE QUICK LINKS

Last Content Update: 02/23/2017

---

## COMPARABLE PARTS

View a parametric search of comparable parts.

## EVALUATION KITS

- HMC859LC3 Evaluation Board

## DOCUMENTATION

### Data Sheet

- HMC859: 26 GHz, Divide-By-8 with Reset & Programmable Output Voltage Data Sheet

## DESIGN RESOURCES

- HMC859 Material Declaration
- PCN-PDN Information
- Quality And Reliability
- Symbols and Footprints

## DISCUSSIONS

View all HMC859 EngineerZone Discussions.

## SAMPLE AND BUY

Visit the product page to see pricing options.

## TECHNICAL SUPPORT

Submit a technical question or find your regional support number.

## DOCUMENT FEEDBACK

Submit feedback for this data sheet.

---



**26 GHz, DIVIDE-BY-8 WITH RESET & PROGRAMMABLE OUTPUT VOLTAGE**

**Electrical Specifications (continued)**

Parameter	Conditions	Min.	Typ.	Max	Units
Output Rise / Fall Time	Differential, 20% - 80%		19 / 17		ps
Output Return Loss	Frequency <14 GHz		10		dB
Random Jitter Jr	rms [1]		0.09	0.13	ps rms
Propagation Delay Clock to Q, td			146		ps
Propagation Delay Reset to Q, tdr			158		ps
VR Pin Current	VR = 0.0 V		3		mA
VR Pin Current	VR = 0.4 V			4.25	mA

[1] Added jitter calculated by de-embedding the clock source jitter.

**DC Current vs. Supply Voltage [1][2]**

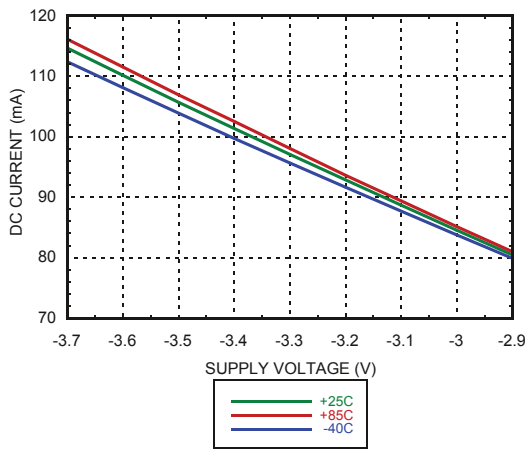

**DC Current vs. VR [2][3]**

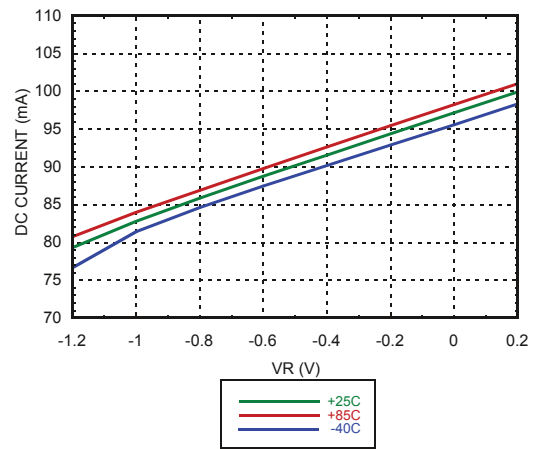

**Output Differential Voltage vs. Supply Voltage [1][2]**

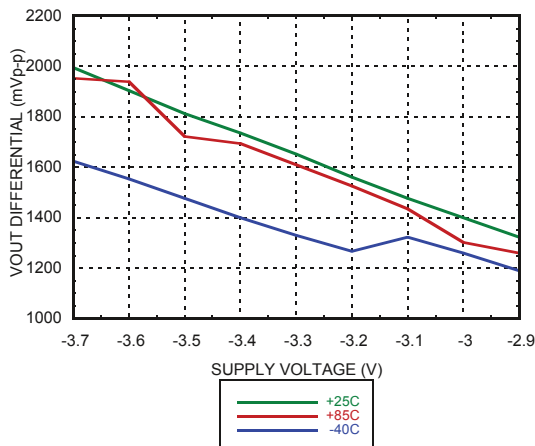

**Output Differential Voltage vs. VR [2][3]**

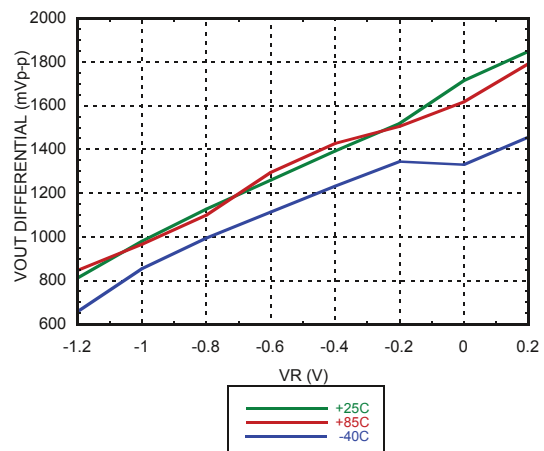

[1] VR = 0.0 V

[2] Frequency = 28 GHz

[3] Vee = -3.3 V



**26 GHz, DIVIDE-BY-8 WITH RESET & PROGRAMMABLE OUTPUT VOLTAGE**

**Rise / Fall Time vs. Supply Voltage [1][2]**

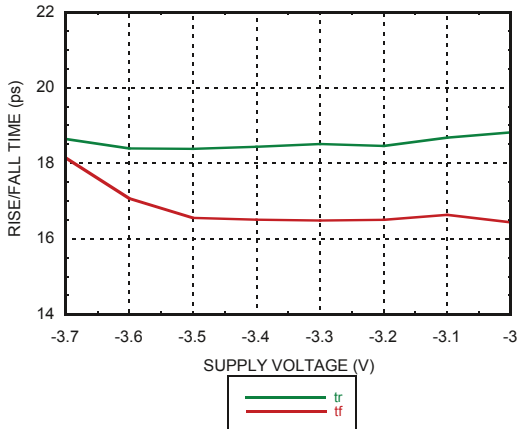

**Rise / Fall Time vs. VR [2][3]**

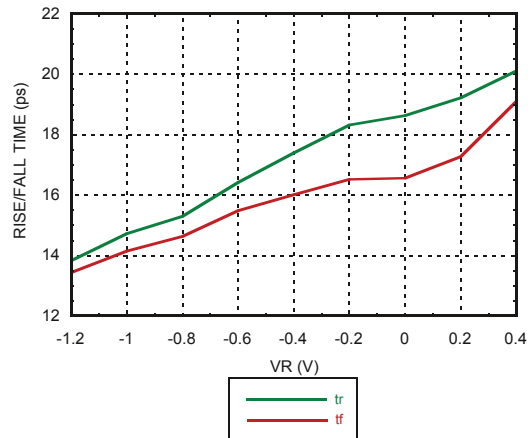

**Clock Output Return Loss [1][2][3][4]**

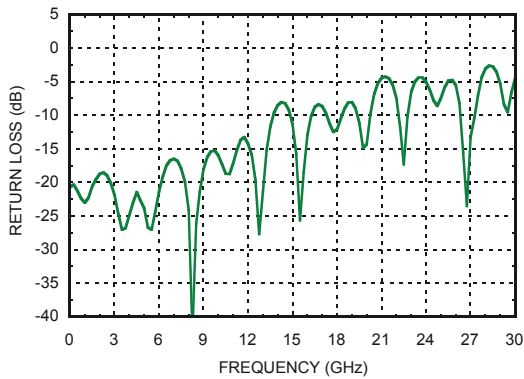

**Clock Input Return Loss [1][2][3][4]**

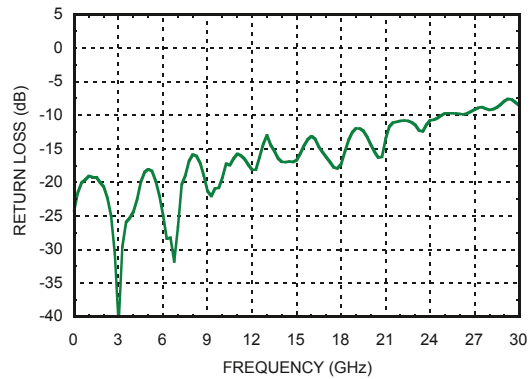

**Reset Input Return Loss [1][2][3][4]**

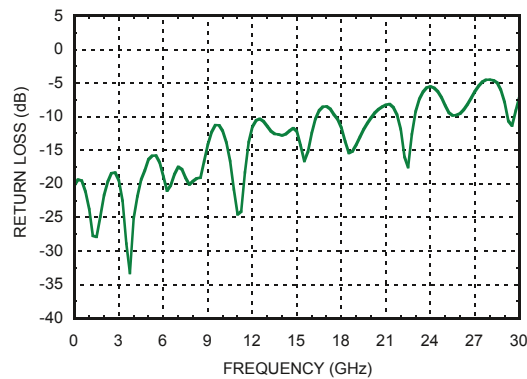

[1] VR = 0.0 V

[2] Frequency = 28 GHz

[3] Vee = -3.3 V

[4] Device measured on evaluation board with gating

**26 GHz, DIVIDE-BY-8 WITH RESET &  
 PROGRAMMABLE OUTPUT VOLTAGE**

**Output Waveform**

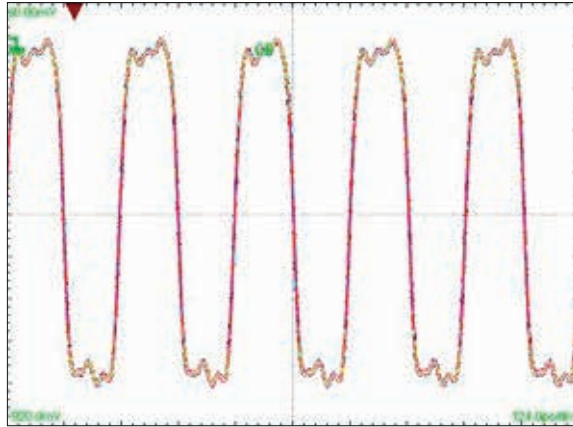

[1] Test Conditions:  
 Waveform generated with a CW signal source input at 28 GHz.  
 Diagram data presented on a Tektronix CSA 8000.

**Timing Diagram**

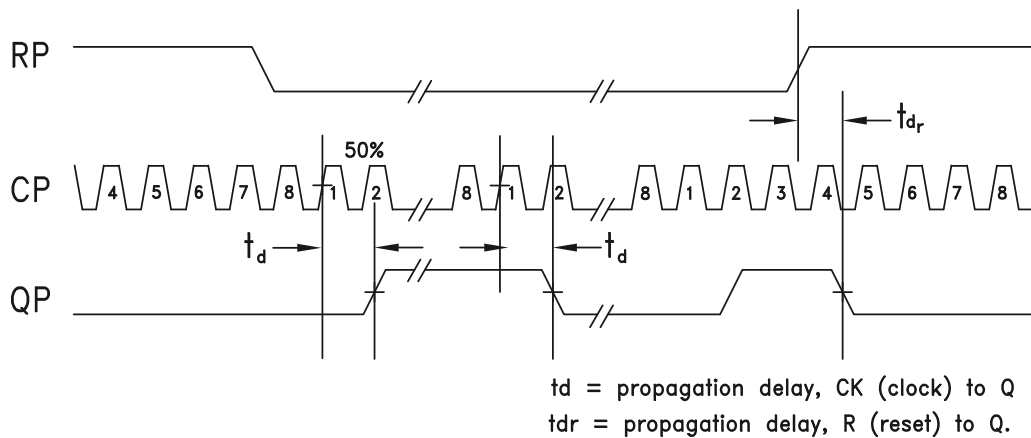

**26 GHz, DIVIDE-BY-8 WITH RESET & PROGRAMMABLE OUTPUT VOLTAGE**

**Absolute Maximum Ratings**

Power Supply Voltage (Vee)	-3.75 V to +0.5 V
Input Signals	-2 V to +0.5 V
Output Signals	-1.5 V to +1 V
Continuous Pdiss (T = 85 °C) (derate 17 mW/°C above 85 °C)	0.68 W
Thermal Resistance (R <sub>th(j-p)</sub> ) Worst Case Junction to Package Paddle	59 °C/W
Storage Temperature	-65 °C to +150 °C
Operating Temperature	-40 °C to +85 °C
Maximum Junction Temperature	125 °C
ESD Sensitivity (HBM)	Class 1B



**ELECTROSTATIC SENSITIVE DEVICE  
 OBSERVE HANDLING PRECAUTIONS**

**Outline Drawing**

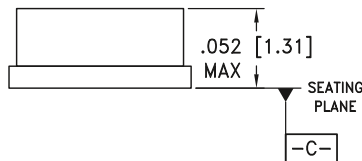
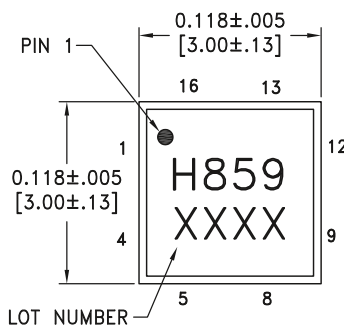

**BOTTOM VIEW**

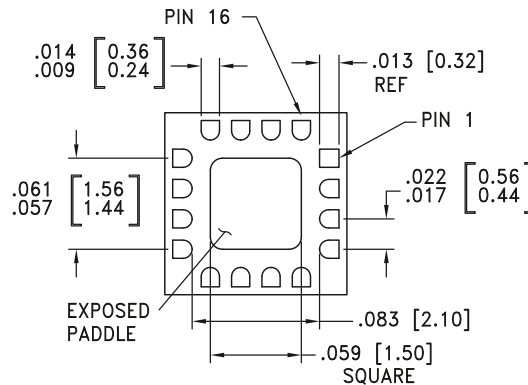

**NOTES:**

1. PACKAGE BODY MATERIAL: ALUMINA
2. LEAD AND GROUND PADDLE PLATING:  
30-80 MICROINCHES GOLD OVER 50 MICROINCHES MINIMUM NICKEL.
3. DIMENSIONS ARE IN INCHES [MILLIMETERS].
4. LEAD SPACING TOLERANCE IS NON-CUMULATIVE.
5. PACKAGE WARP SHALL NOT EXCEED 0.05mm DATUM -C-
6. ALL GROUND LEADS MUST BE SOLDERED TO PCB RF GROUND.
7. PADDLE MUST BE SOLDERED TO Vee.

**Package Information**



Part Number	Package Body Material	Lead Finish	MSL Rating	Package Marking <sup>[2]</sup>
HMC859LC3	Alumina, White	Gold over Nickel	MSL3 <sup>[1]</sup>	H859 XXXX

[1] Max peak reflow temperature of 260 °C

[2] 4-Digit lot number XXXX

**26 GHz, DIVIDE-BY-8 WITH RESET &  
PROGRAMMABLE OUTPUT VOLTAGE**

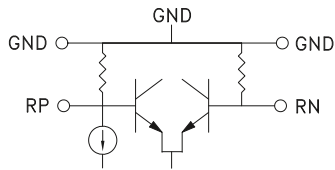
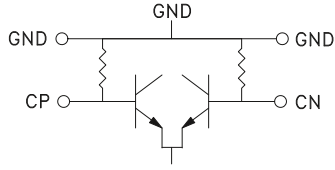
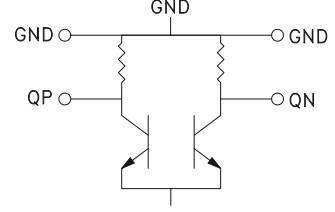
**Pin Descriptions**

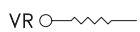
Pin Number	Function	Description	Interface Schematic
1, 4, 5, 8, 9, 12	GND	Signal Grounds	
2, 3	RP, RN	Differential Reset Inputs: Current Mode Logic (CML) referenced to positive supply.	
6, 7	CP, CN	Differential Clock Inputs: Current Mode Logic (CML) referenced to positive supply.	
10, 11	QN, QP	Differential Clock Outputs: Current Mode Logic (CML) referenced to positive supply.	
13, 16	GND	Supply Ground	
14	VR	Output level control. Output level may be increased or decreased by applying a voltage to VR per "Output Differential vs. VR" plot.	
15, Package Base	Vee	This pin and the exposed paddle must be connected to the negative voltage supply.	

**26 GHz, DIVIDE-BY-8 WITH RESET & PROGRAMMABLE OUTPUT VOLTAGE**

**Evaluation PCB**

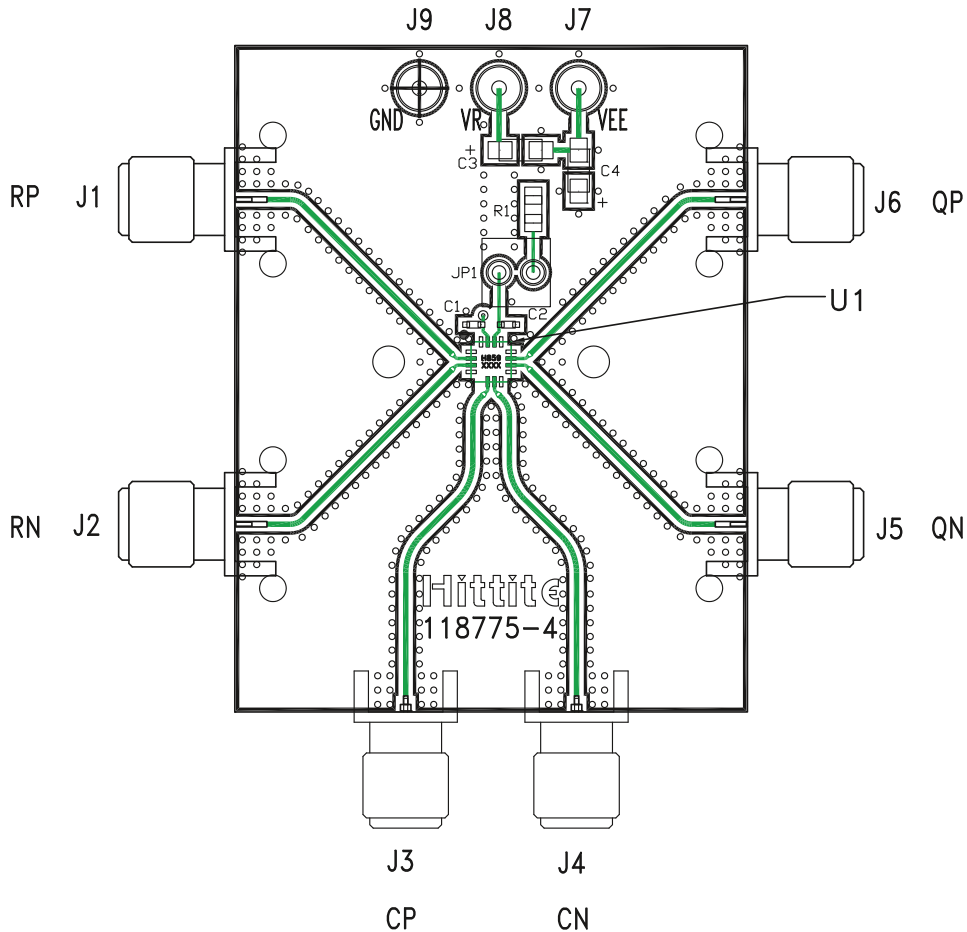

**List of Materials for Evaluation PCB 123585 [1]**

Item	Description
J1, J2, J5, J6	PCB Mount SMA RF Connectors
J3, J4	PCB Mount 2.92mm RF Connectors
J7 - J9	DC Pin
JP1	2-Position Header with Shunt
C1 - C2	100 pF Capacitor, 0402 Pkg.
C3 - C4	4.7 μF Capacitor, Tantalum
R1	10 Ohm Resistor, 0603 Pkg.
U1	HMC859LC3 Clock Divider
PCB [2]	118775 Evaluation Board

[1] Reference this number when ordering complete evaluation PCB

[2] Circuit Board Material: Arlon 25FR or Rogers 4350

The circuit board used in the application should use RF circuit design techniques. Signal lines should have 50 Ohm impedance while the package ground leads should be connected directly to the ground plane similar to that shown. The exposed packaged base should be connected to Vee. A sufficient number of via holes should be used to connect the top and bottom ground planes. The evaluation circuit board shown is available from Hittite upon request. Install jumper on JP1 to short VR to GND for normal operation.



**26 GHz, DIVIDE-BY-8 WITH RESET &  
 PROGRAMMABLE OUTPUT VOLTAGE**

**Application Circuit**

