

SERPAC CH6

Electronic Enclosures

NOTES:

1) When machine or I-plates modifications are required, use the center of the enclosure to dimension.

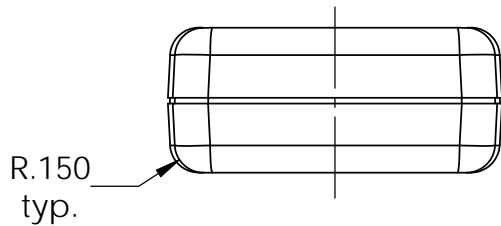
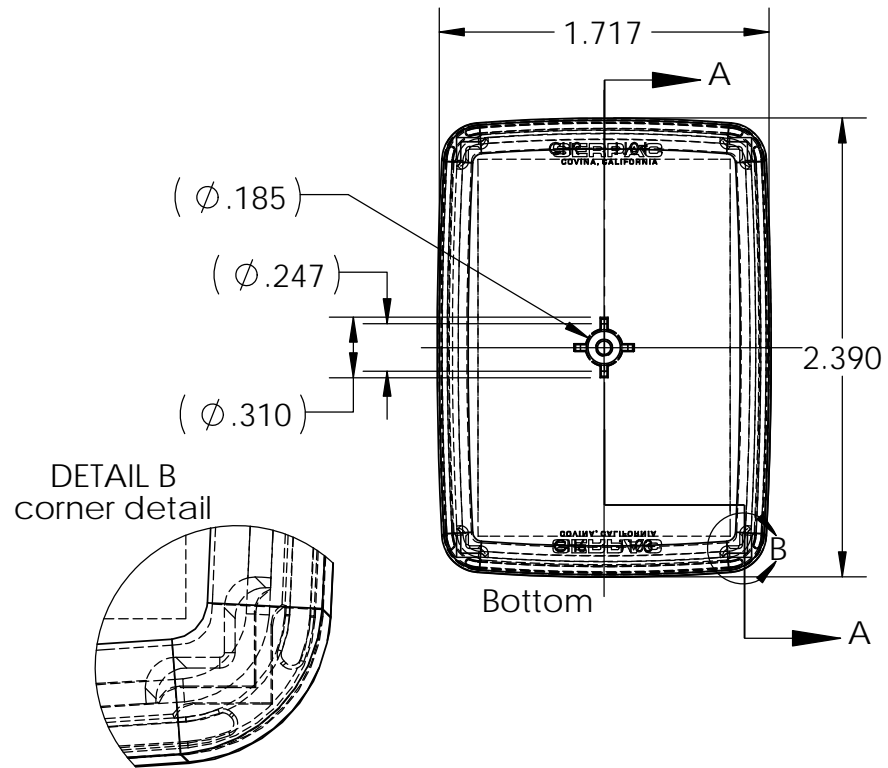
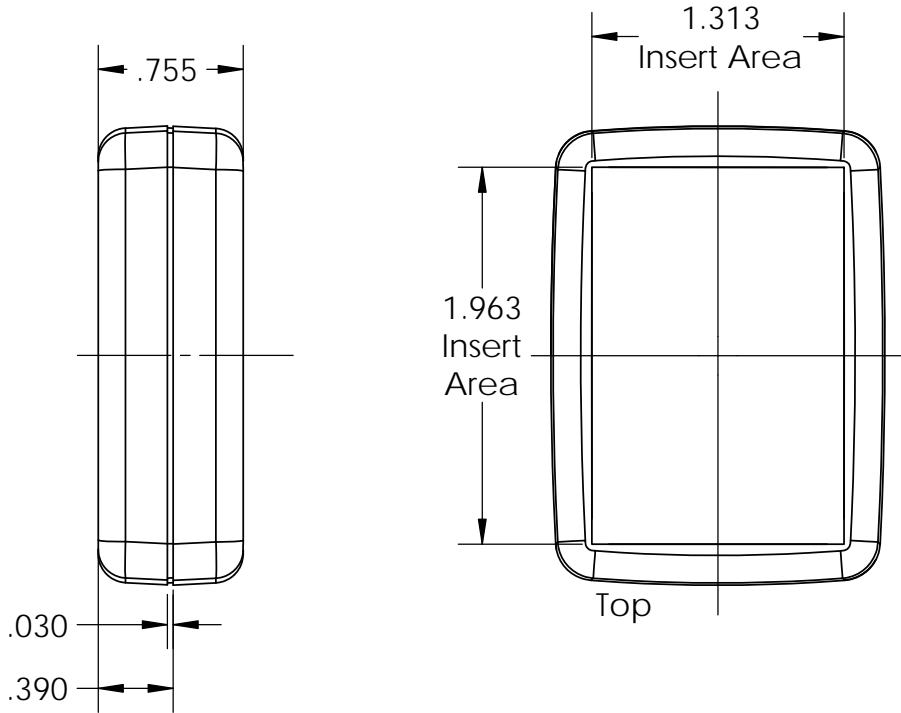

Enclosure can hold either a 0.032" PCB or a 0.063 PCB
 PCB dimensions are: (PCB drawings on page 2)
 0.032" [.8mm] PCB 2.16" X 1.52" (0.20" center hole)
 0.063" [1.6mm] PCB 2.12" X 1.48" (0.26" center hole)

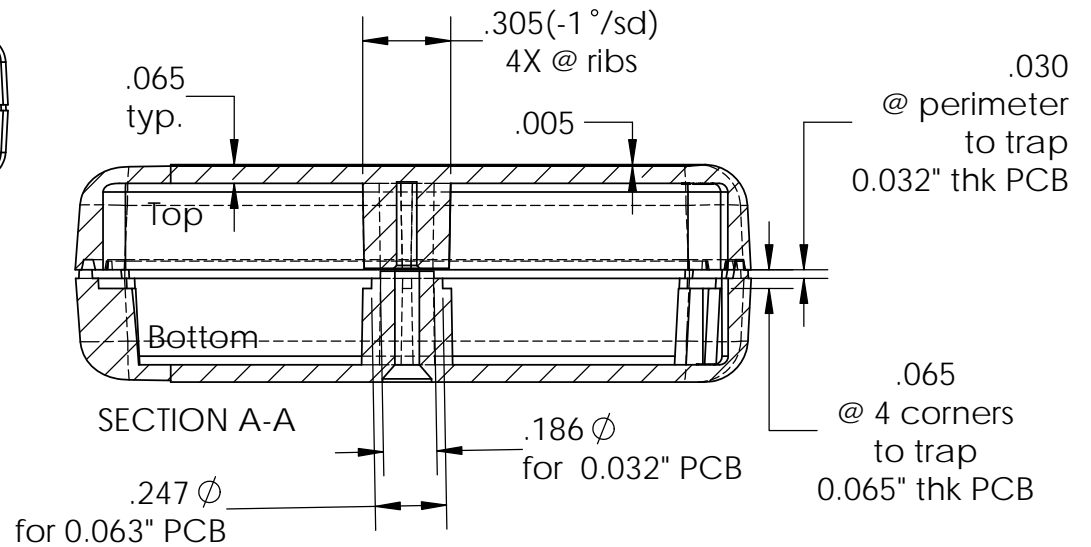

PART NO.	DESCRIPTION	ACCESSORIES	
1103	CH6 TOP	PART NO.	DESCRIPTION
1104	CH6 BOTTOM	55	KEY HOLDER
6007	SCREW 2x3/4" PHILFLAT H/L (1)		

SERPAC CIRCUIT BOARD CH6

Electronic Enclosures

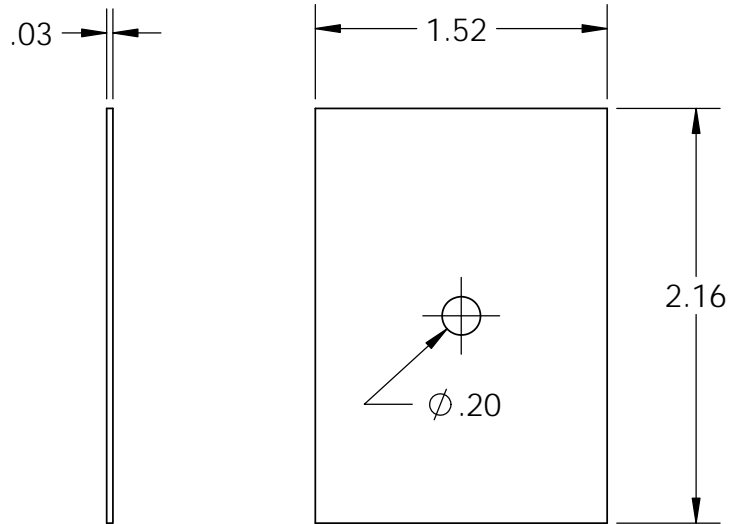

.032 board

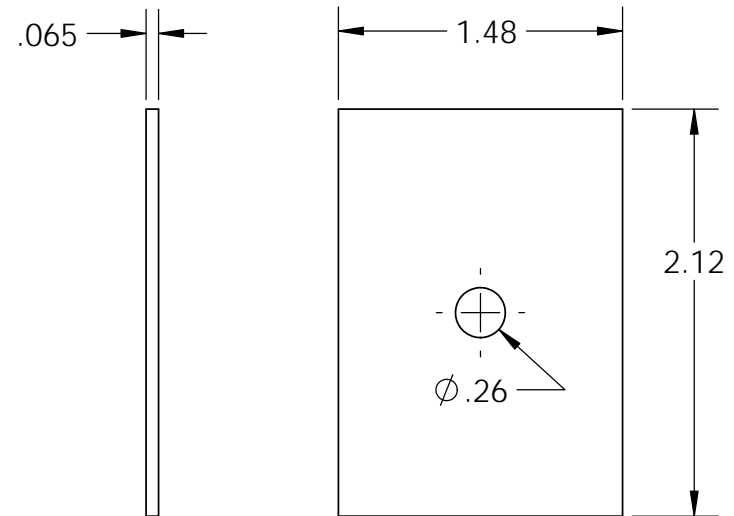

.065 board

NOTES:
These are suggested dimensions.
Plastic parts have a ± 0.010 " manufacturing tolerance.