

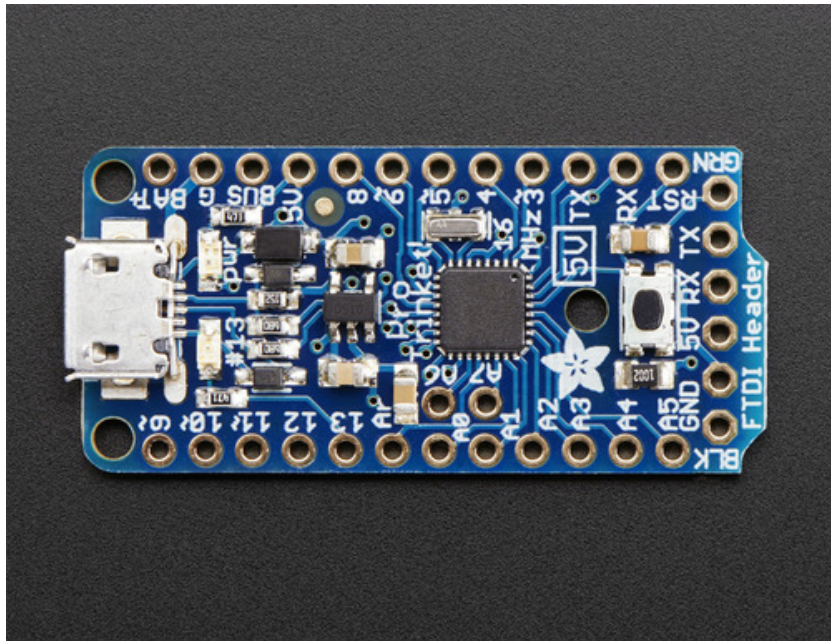

Introducing Pro Trinket

Created by lady ada



Last updated on 2014-09-18 09:15:14 PM EDT

Guide Contents

Guide Contents	2
Overview	4
Guided Tour	11
Pinouts	13
Power Pins	13
GPIO Pins	14
Logic Level	14
The Digital Only GPIO Pins	15
The Analog/Digital GPIO Pins	16
The Analog only pins	17
Other Pins	18
FTDI Breakout	19
Using the USB Bootloader	21
About the bootloader	21
Pro Trinket USB Drivers for Windows	21
Special Notes on using Pro Trinket with Linux	22
How to start the USB bootloader	23
Using FTDI Cables	24
Select the correct Board in IDE	26
Connect FTDI Friend or Cable	27
Setting up Arduino IDE	29
The Fast Way	29
Mac OSX	30
Linux	30
The Slow Way	30
Step 0. Install Arduino IDE	30
Step 1. Download and add Pro Trinket folder	31

Blink!	32
Something Went Wrong!	34
If you get the error message avrdude: Error: Could not find USBtiny device (0x1781/0xc9f)	34
Hints for Arduino-compatibility	36
Downloads	38
Windows Driver	38
Source code	38
Schematics	38
Pro Trinket 5V 16MHz:	38
Pro Trinket 3V @ 12MHz	39

Overview

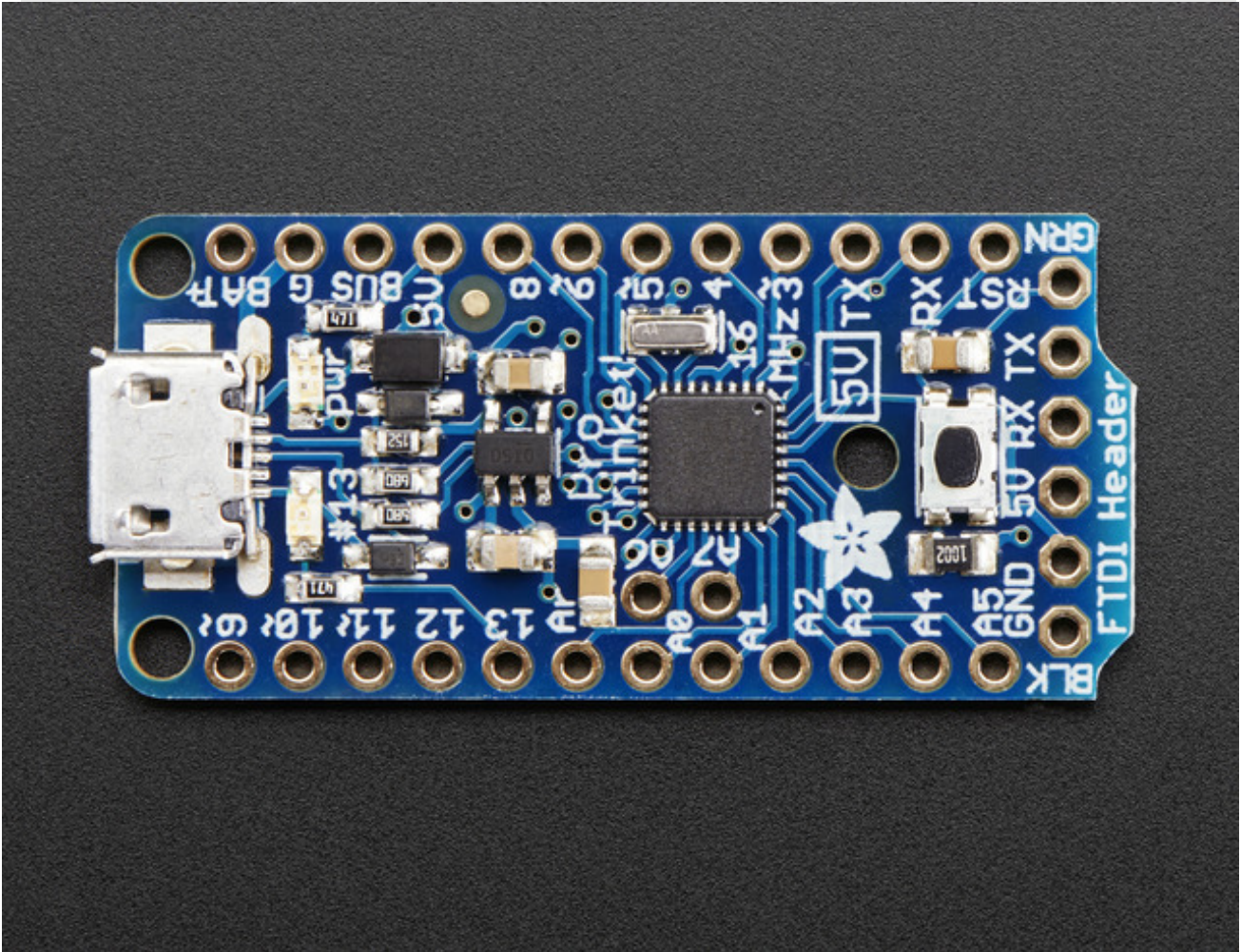

Trinket's got a big sister in town - the Pro Trinket! Pro Trinket combines everything you love about Trinket with the familiarity of the core Arduino chip, the ATmega328. It's like an Arduino Pro Mini with more pins and USB tossed in.

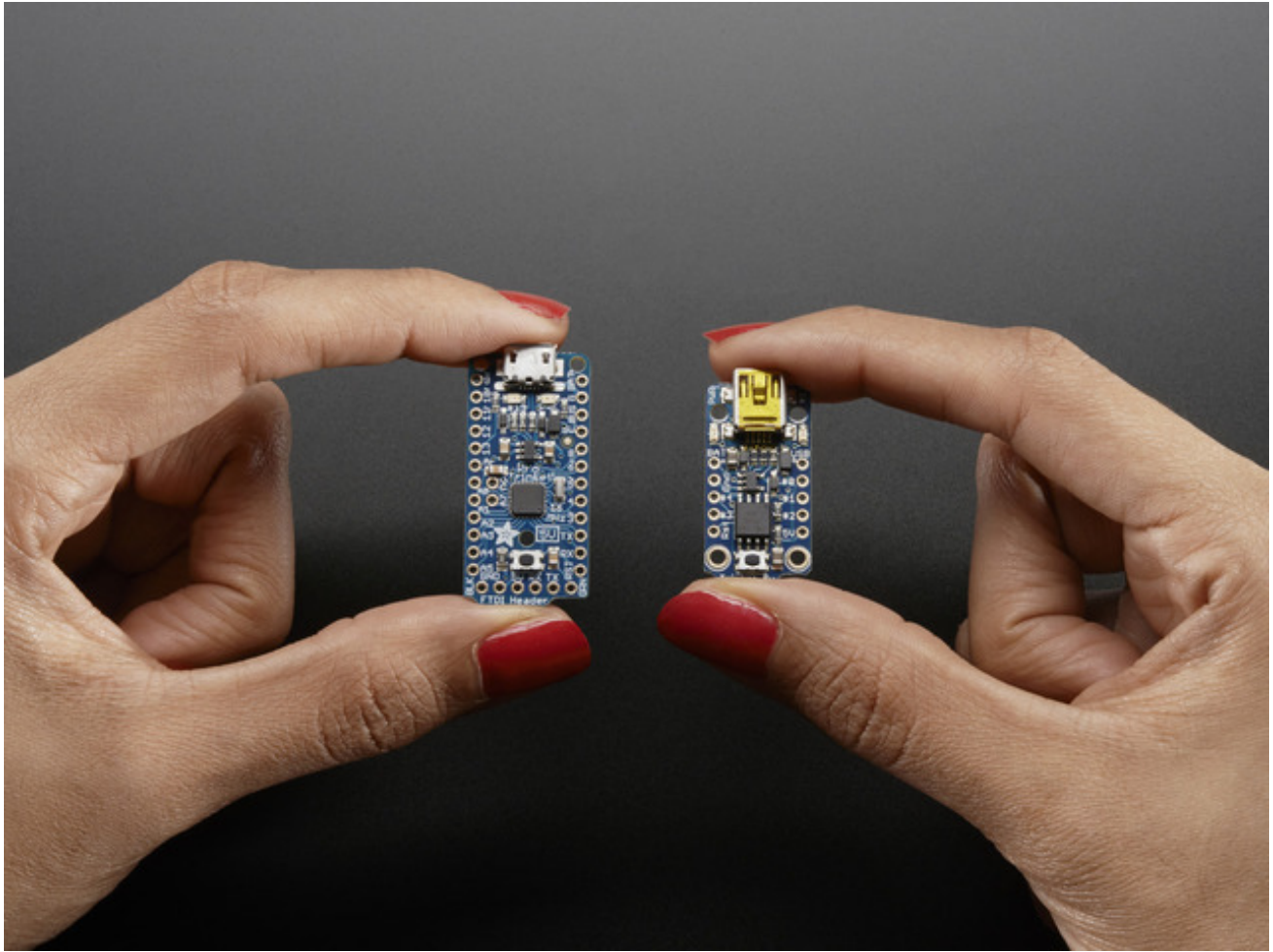

Trinket's a year old now, and while its been great to see tons of tiny projects, sometimes you just need more pins, more FLASH, and more RAM. That's why we designed Pro Trinket, with 18 GPIO, 2 extra analog inputs, 28K of flash, and 2K of RAM.

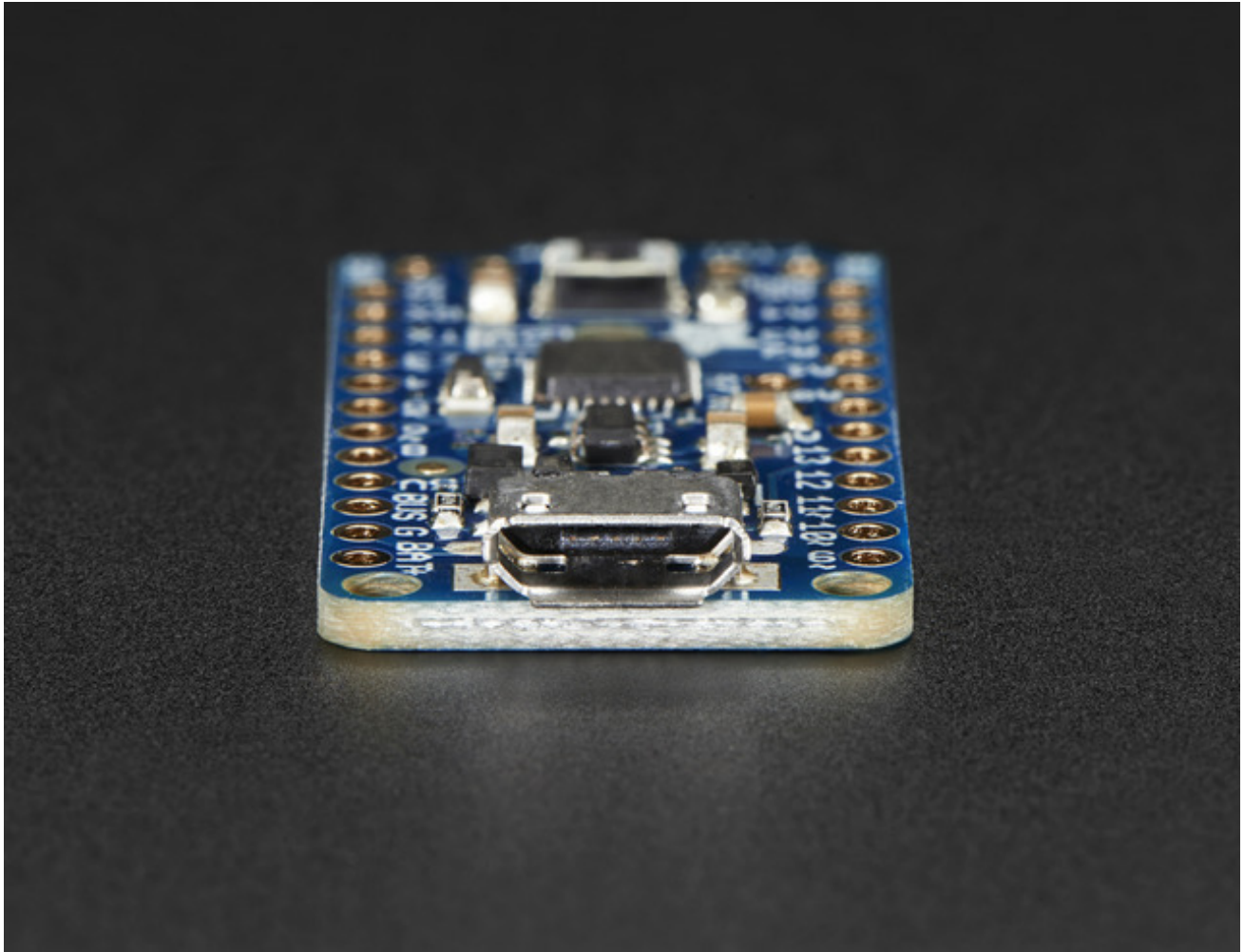

Like the Trinket, it has onboard USB bootloading support - we opted for a MicroUSB jack this time. We also added Optiboot support, so you can either program your Pro Trinket over USB or with a FTDI cable just like the Pro Mini and friends.

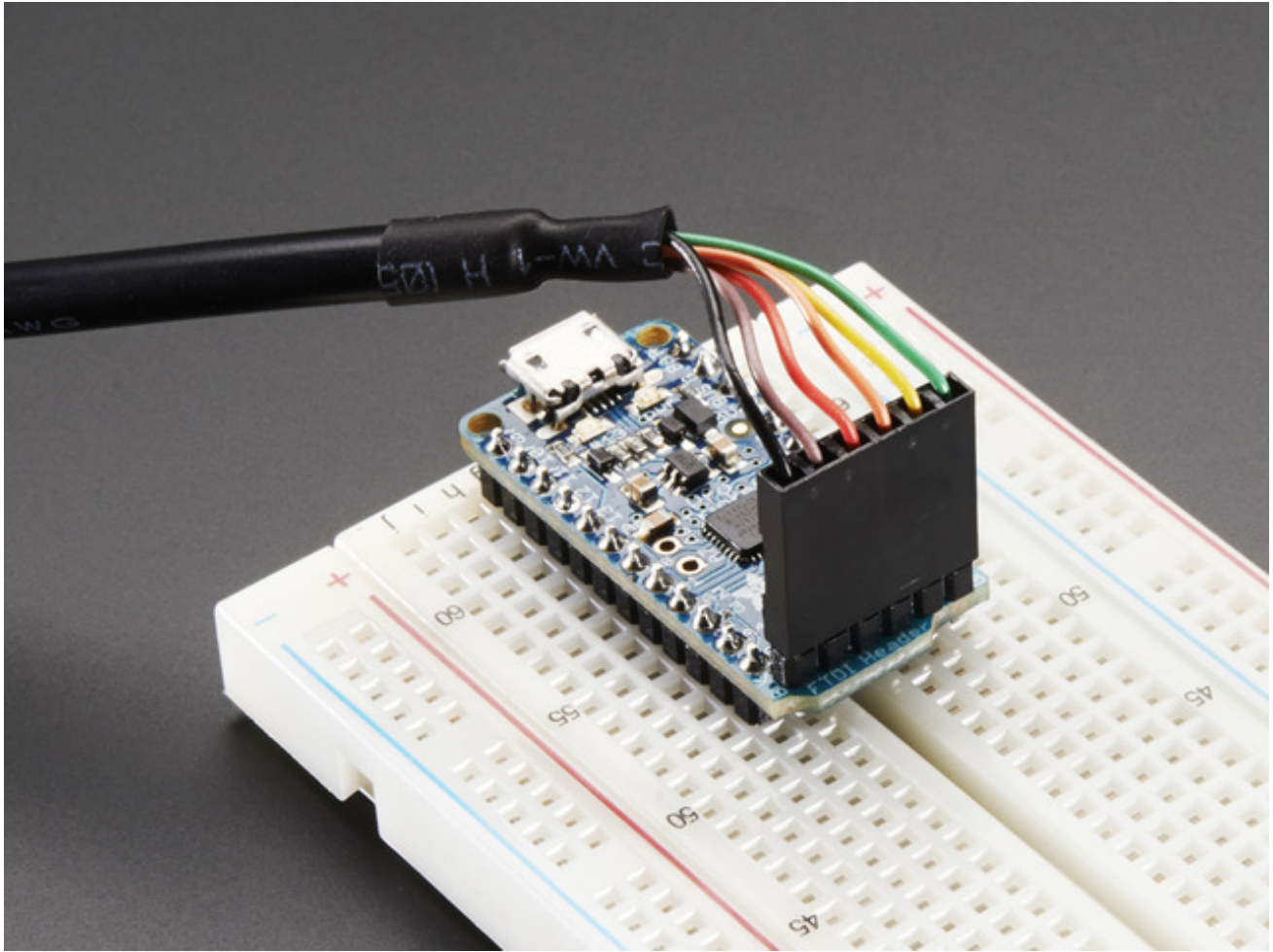

The Pro Trinket PCB measures only 1.5" x 0.7" x 0.2" (without headers) but packs the same capability as an Arduino UNO. So it's great once you've finished up a prototype on an official Arduino UNO and want to make the project smaller.

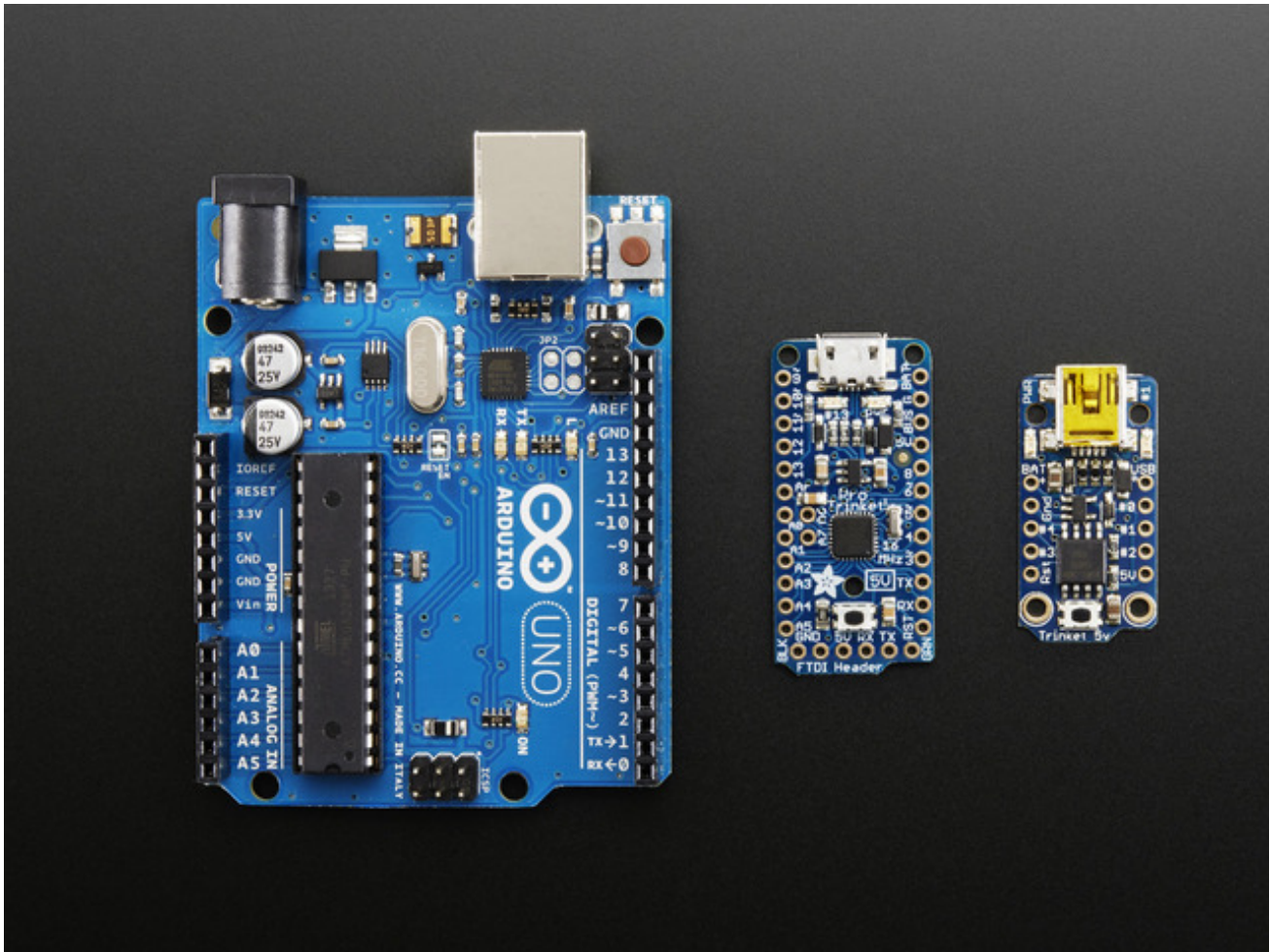

The Pro Trinket 5V uses the Atmega328P chip, which is the same core chip in the Arduino UNO/Duemilanove/Mini/etc. at the same speed and voltage. So you'll be happy to hear that not only is Pro Trinket programmable using the Arduino IDE as you already set up, but 99% of Arduino projects will work out of the box!

Here's some things you may have to consider when adapting Arduino sketches:

- Pins #2 and #7 are not available (they are exclusively for USB)
- The onboard 5V regulator can provide 150mA output, not 800mA out
- You cannot plug shields directly into the Pro Trinket
- There is no Serial-to-USB chip onboard. This is to keep the Pro Trinket small and inexpensive, you can use any FTDI cable to connect to the FTDI port for a Serial connection. The USB connection is for uploading new code only.
- The bootloader on the Pro Trinket use 4KB of FLASH so the maximum sketch size is 28,672 bytes. The bootloader does not affect RAM usage.
- Trinket is not supported on Linux operating system at this time - try Mac OS or Windows!

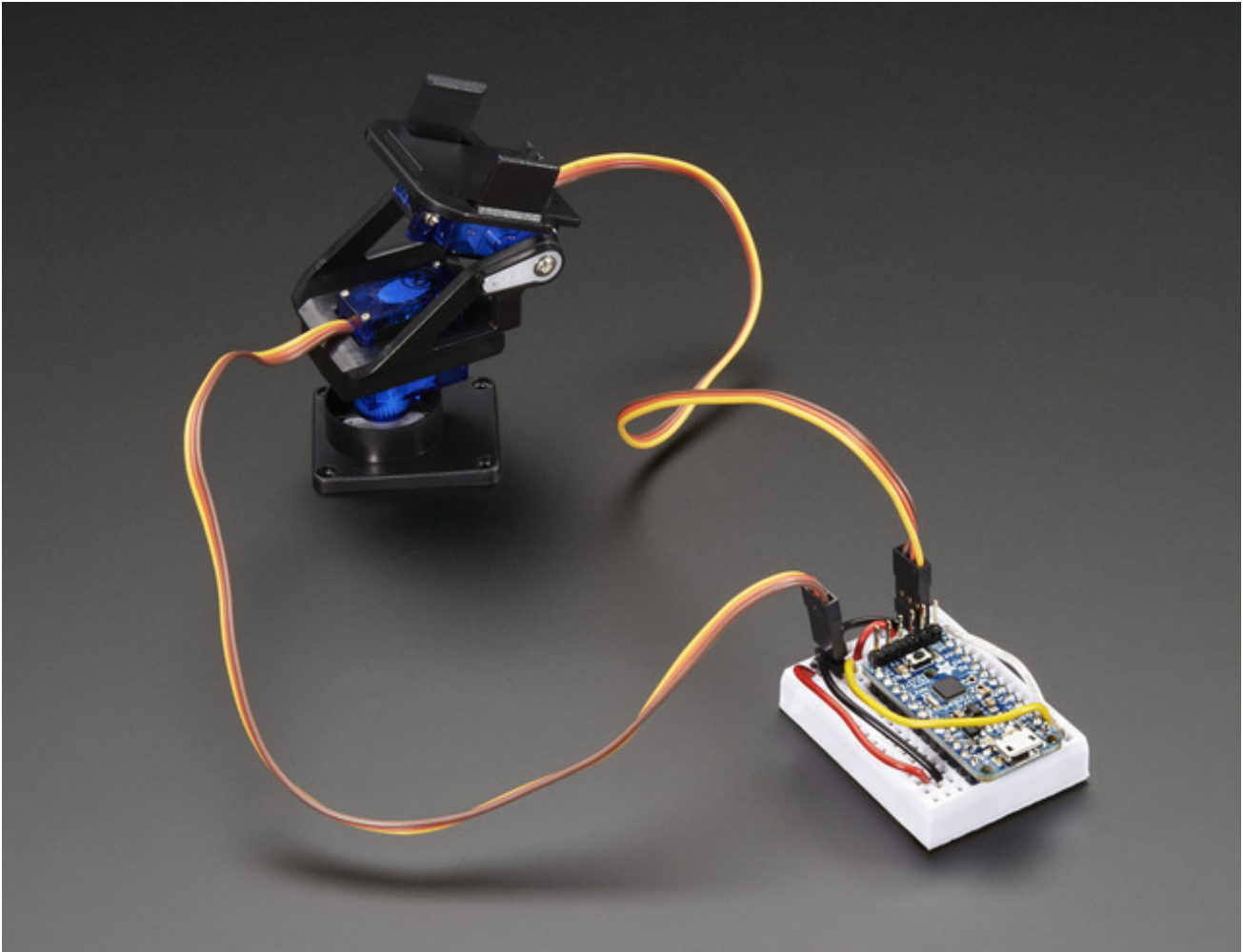

Here's some handy specifications:

- ATmega328P onboard chip in QFN package
- 16MHz clock rate, 28K FLASH available
- USB bootloader with a nice LED indicator looks just like a USBtinyISP so you can program it with AVRdude and/or the Arduino IDE (with a few simple config modifications).
- Also has headers for an FTDI port for reprogramming
- Micro-USB jack for power and/or USB uploading, you can put it in a box or tape it up and use any USB cable for when you want to reprogram.
- On-board 5.0V power regulator with 150mA output capability and ultra-low dropout. Up to 16V input, reverse-polarity protection, thermal and current-limit protection.
- Power with either USB or external output (such as a battery) - it'll automatically switch over
- On-board green power LED and red pin #13 LED
- Reset button for entering the bootloader or restarting the program.
- Works with 99% of existing Arduino sketches (anything that doesn't use more than 28K, and doesn't require pins #2 and #7)
- **Mounting holes! Yeah!**

Guided Tour

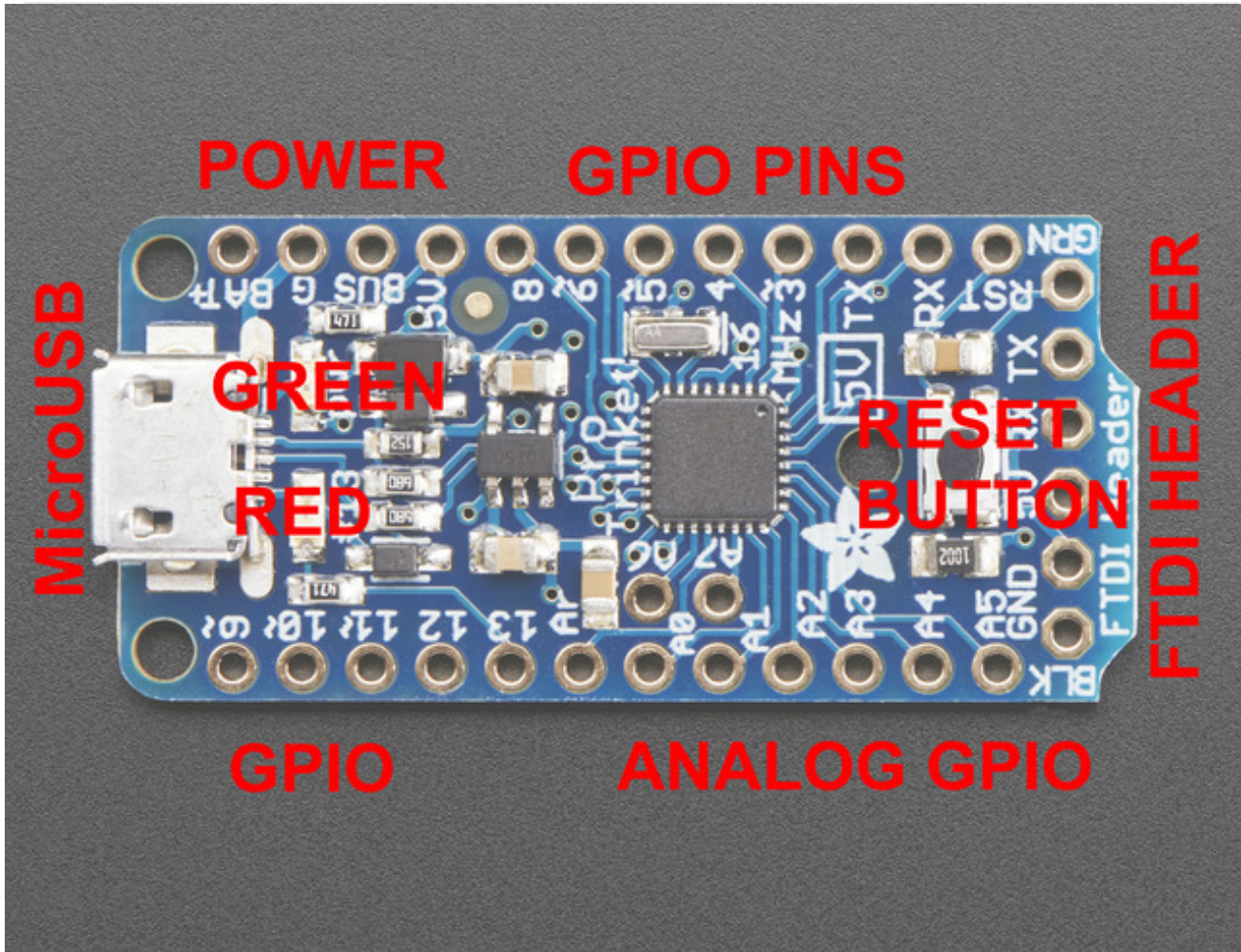

Let me take you on a tour of your Trinket! Each trinket is assembled here at Adafruit and comes chock-full of good design to make it a joy to use.

- **Micro-B USB connector** - We went with the ultra-common micro-B USB connector for power and/or USB bootloading. We use a special half SMT/half thru hole connector with extra big pads so the connector is very strong. It's also a proper USB connector, so you can use any length cable. Don't forget to use a data+power USB cable if you want to bootload! Some really inexpensive USB cables are 'power only'
- **Green Power LED** - you'll know that the board is powered up when this bright LED is lit
- **Red #13 LED** - this LED does double duty. Its connected with a series resistor to the digital #13 GPIO pin. It pulses or blinks nicely when the Pro Trinket is in bootloader mode, and its also handy for when you want an indicator LED.
- **Battery + Input** - take your Trinket anywhere and power it from an external battery. This pin can take up 16V DC input, and has reverse-polarity, over-current and thermal protections. The circuitry inside will use either the battery or USB power, safely switching from one to the other. If both are connected, it will use whichever has the

higher voltage

- **USB Power Output** - You can also snag the 5V power from the USB jack in case you need 500mA+ current from your computer or portable USB power pack.
- **Breadboard friendly pins** - You can easily plug this into a little breadboard and have plenty of space for working and plugging stuff in
- **GPIO pins** - 18 GPIO pins + 2 analog-only pins, at 3 or 5V logic, check the next section for a detailed pinout guide
- **3 or 5V output** - an onboard regulator provides 3.3V or 5V output for powering LEDs, sensors, small motors, etc.
- **Reset Button** - an onboard reset button will launch the bootloader when pressed and the Trinket is plugged into a computer. If it is not connected to a computer, it's smart enough to go straight to the program.
- **External Reset Pin** - we bring out the reset pin so you can reset or restart your Trinket on the road. If the Trinket is in a box or otherwise hard to get to, you can wire up a button to this pin for an external reset button.
- **Three mounting holes** make it easy to attach with 2mm screws (M2 metric or #2 imperial) or even tiny zip-ties, string, etc.

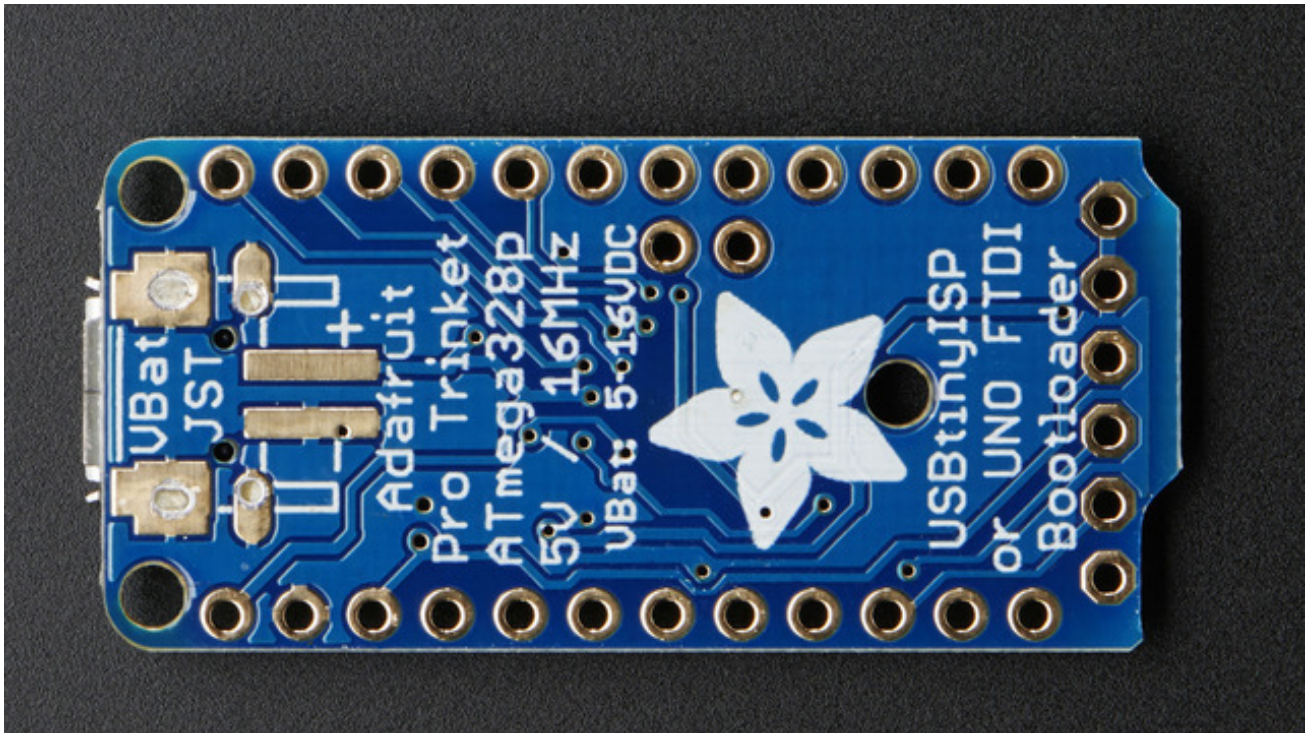

On the bottom there's a spot for a [2-pin JST-PH connector](http://adafru.it/1769) (<http://adafru.it/1769>), this is optional and can be soldered on by hand. It will let you use a lipoly or [AAA battery pack](http://adafru.it/727) (<http://adafru.it/727>) or a [JST cable](http://adafru.it/drM) (<http://adafru.it/drM>) for other power input. It's connected to the GND and VBAT pins

Pinouts

There are two versions of the Pro Trinket: 3V and 5V. They are almost identical but there are slight differences in the pinouts: one has a 3V output pin in the top right, the other has a 5V output pin instead

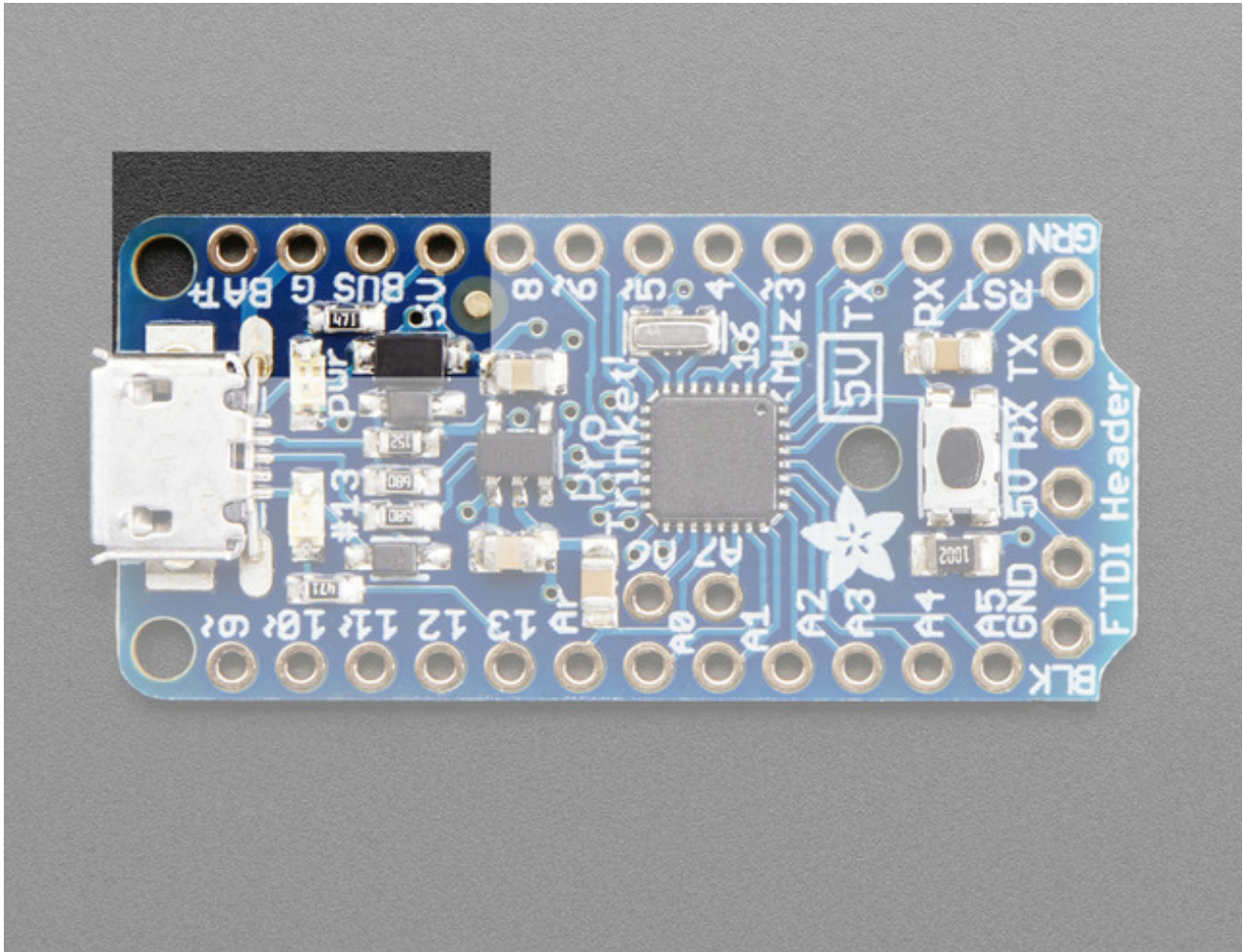

Power Pins

We'll start with the top pins **BAT+**, **USB+**, **3V/5V**, and **GND**

- **BAT+** is the **Battery + Input** pin. If you want to power the Pro Trinket from a battery or power adapter or solar panel or any other kind of power source, connect the + (positive) pin here! You can connect up to 16V DC. If you have a 3V Pro Trinket, you'll want at least 3.5V input to get a good 3.3V output. If you have a 5V Pro Trinket, 5.5V or higher is suggested. This input is reverse-polarity protected.
- **BUS** is the **USB Bus + Output** pin. If you want to use the USB 5V power for something, like charging a battery, or if you need more than 150mA of current (this pin

can supply 500mA+ from USB ports) or to detect when the Pro Trinket is plugged into USB, this pin will have 5V power on it if and only if its plugged into something via the mini B connector

- **GND** is the common ground pin, used for logic and power. It is connected to the USB ground and the power regulator, etc. This is the pin you'll want to use for any and all ground connections

GPIO Pins

Next we will cover the 18 GPIO (General Purpose Input Output) pins! 18 GPIO is a big step up from the little Trinket with only 5 or so pins. This is almost as many as a 'full grown' Arduino. In fact, since the Pro Trinket uses the same core chip as an Arduino, nearly any existing project that uses special pins like hardware PWM or SPI will work 'out of the box'.

All the GPIO pins can be used as digital inputs, digital outputs, for LEDs, buttons and switches etc. They can provide up to 20mA of current. Don't connect a motor or other high-power component directly to the pins! [Instead, use a transistor to power the DC motor on/off \(http://adafru.it/aUD\)](http://adafru.it/aUD)

Logic Level

On a 3V Pro Trinket, the GPIO are 3.3V output level, and should not be used with 5V inputs. On a 5V Pro Trinket, the GPIO are 5V output level, and can be used with 3V inputs but may damage electronic devices that are 3V input only!

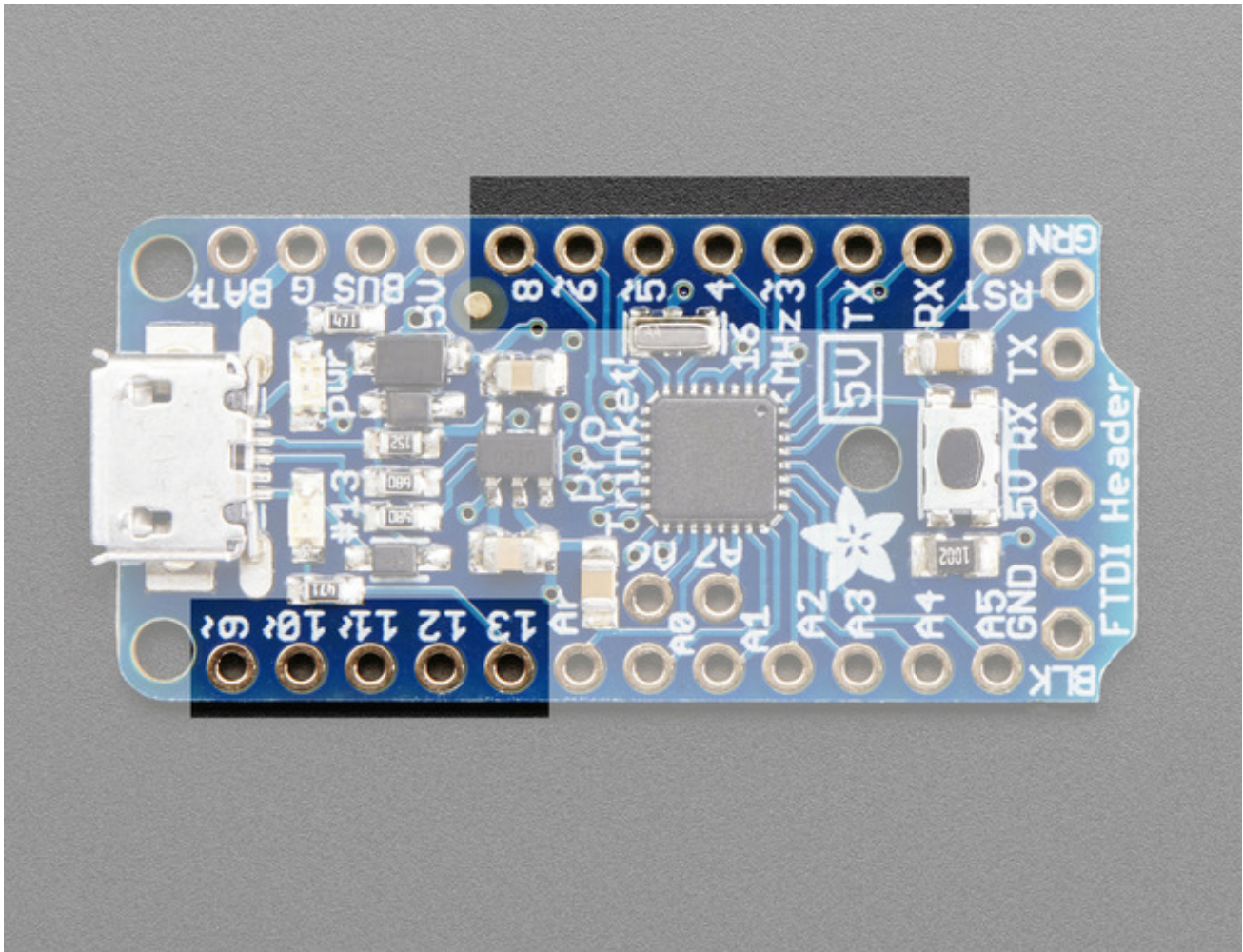

The Digital Only GPIO Pins

- **RX** - also known as Digital #0, this is the hardware serial input pin
- **TX** - also known as Digital #1, this is the hardware serial output pin
- **Digital 3** - this pin can also be used as a PWM output pin using **analogWrite()**
- **Digital 4** - Nothing particularly special about this GPIO pin
- **Digital 5** - this pin can also be used as a PWM output pin using **analogWrite()**
- **Digital 6** - this pin can also be used as a PWM output pin using **analogWrite()**
- **Digital 8** - Nothing particularly special about this GPIO pin
- **Digital 9** - this pin can also be used as a PWM output pin using **analogWrite()** It's also good for driving servos because its a high-speed PWM output
- **Digital 10** - this pin can also be used as a PWM output pin using **analogWrite()** It's also good for driving servos because its a high-speed PWM output
- **Digital 11** - Also known as the SPI **MOSI** pin. this pin can also be used as a PWM output pin using **analogWrite()**
- **Digital 12** - Also known as the SPI **MISO** pin
- **Digital 13** - Also known as the SPI **CLOCK** pin

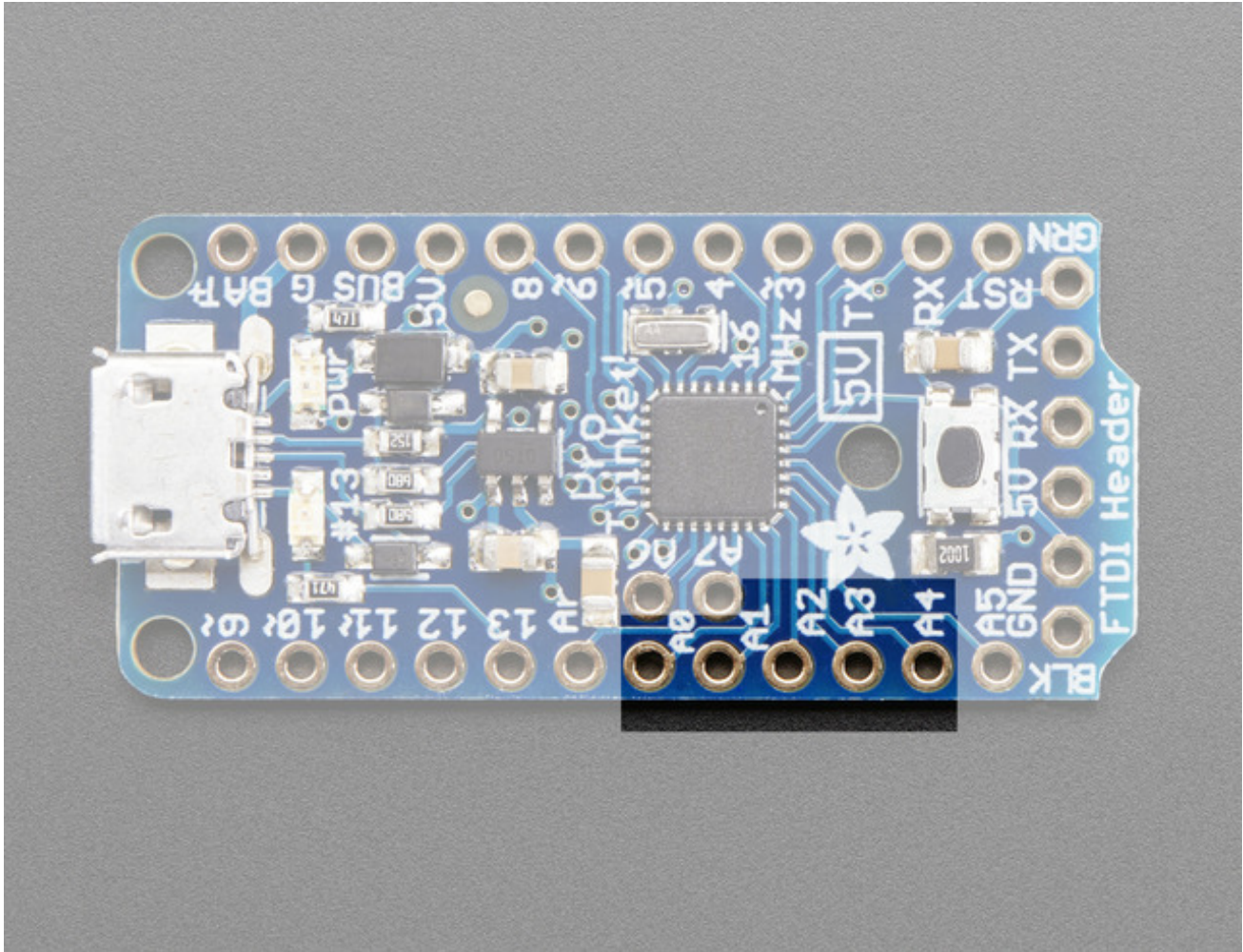

The Analog/Digital GPIO Pins

- **Analog 0** - also known as **Digital 14**, this pin can be a digital I/O pin or an analog input pin
- **Analog 1** - also known as **Digital 15**, this pin can be a digital I/O pin or an analog input pin
- **Analog 2** - also known as **Digital 16**, this pin can be a digital I/O pin or an analog input pin
- **Analog 3** - also known as **Digital 17**, this pin can be a digital I/O pin or an analog input pin
- **Analog 4** - also known as **Digital 18**, this pin can be a digital I/O pin or an analog input pin. It's also the I2C **SDA** pin
- **Analog 5** - also known as **Digital 19**, this pin can be a digital I/O pin or an analog input pin. It's also the I2C **SCL** pin

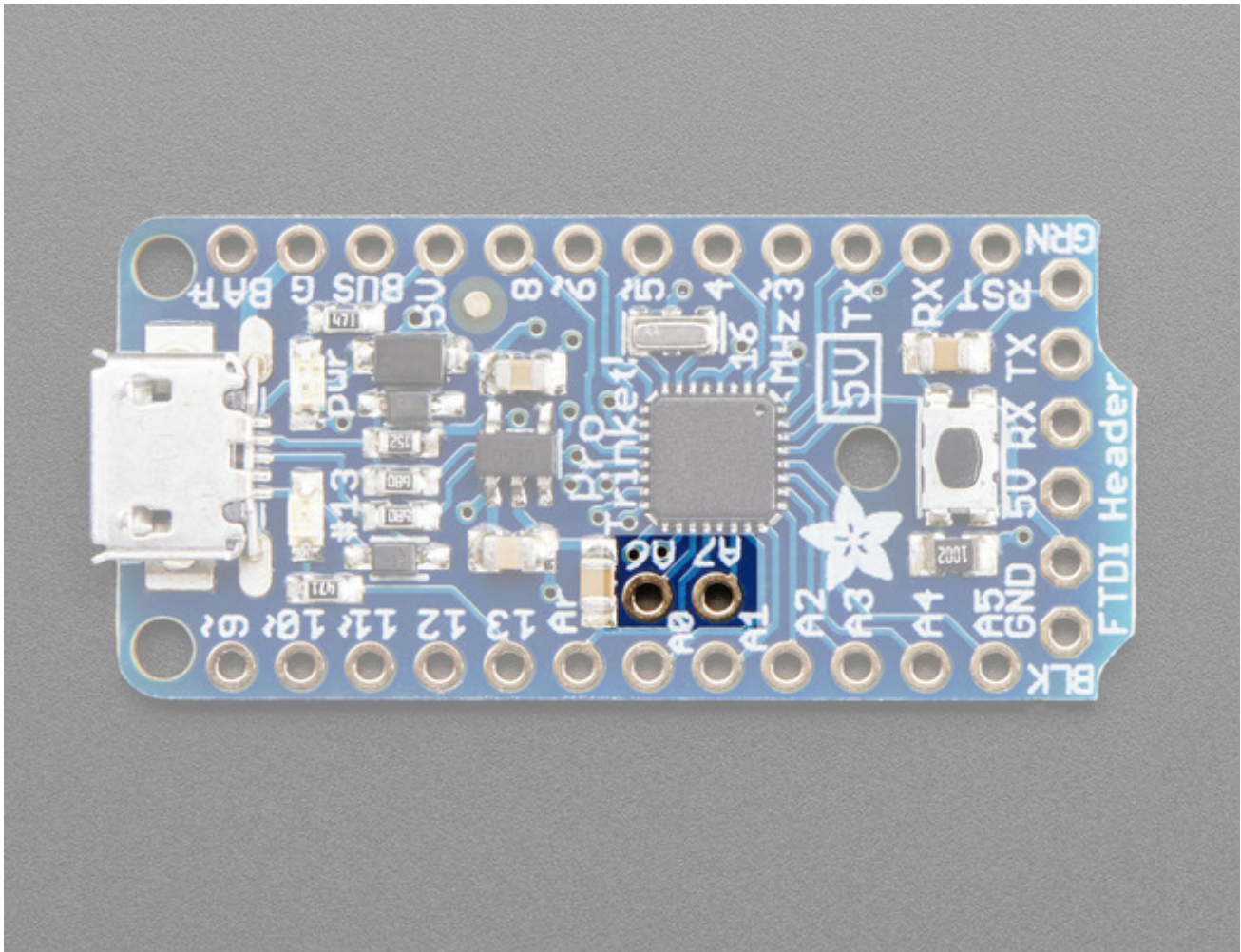

The Analog only pins

The two pins that sit sort-of inside the body of the Pro Trinket, **A6** and **A7**, are analog input only pins. They're kind of an 'extra' that you get with the Pro Trinket. These pins **cannot** be used for LEDs, buttons, servos, etc. They're only for **analogRead()** usage!

If you're used to using an Arduino Uno, you may notice that pins #2 and #7 are not available. That's because we use those two pins for the USB bootloader. They are not available for use and are not broken out.

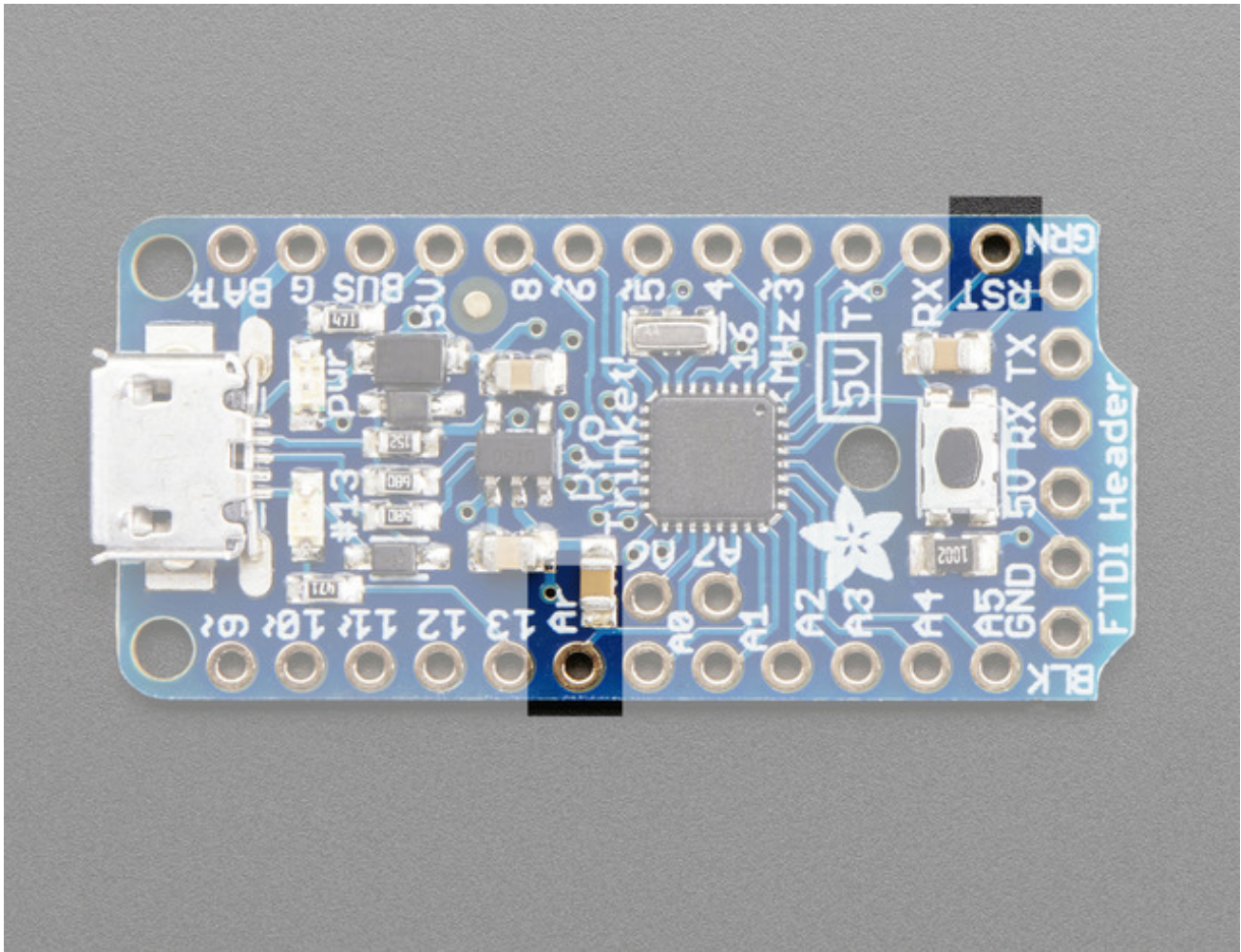

Other Pins

- **Aref** - this is the optional analog reference pin for the analog converter, to be used when you want the 'top' of the analog converter to be different than 3V or 5V. Connect this to your desired reference voltage (between 0 and the Pro Trinket voltage) and use **analogReference(EXTERNAL)**
- **RST** - This is the Reset pin for the Pro Trinket. Connecting this to ground momentarily resets the Trinket and also starts up the bootloader.

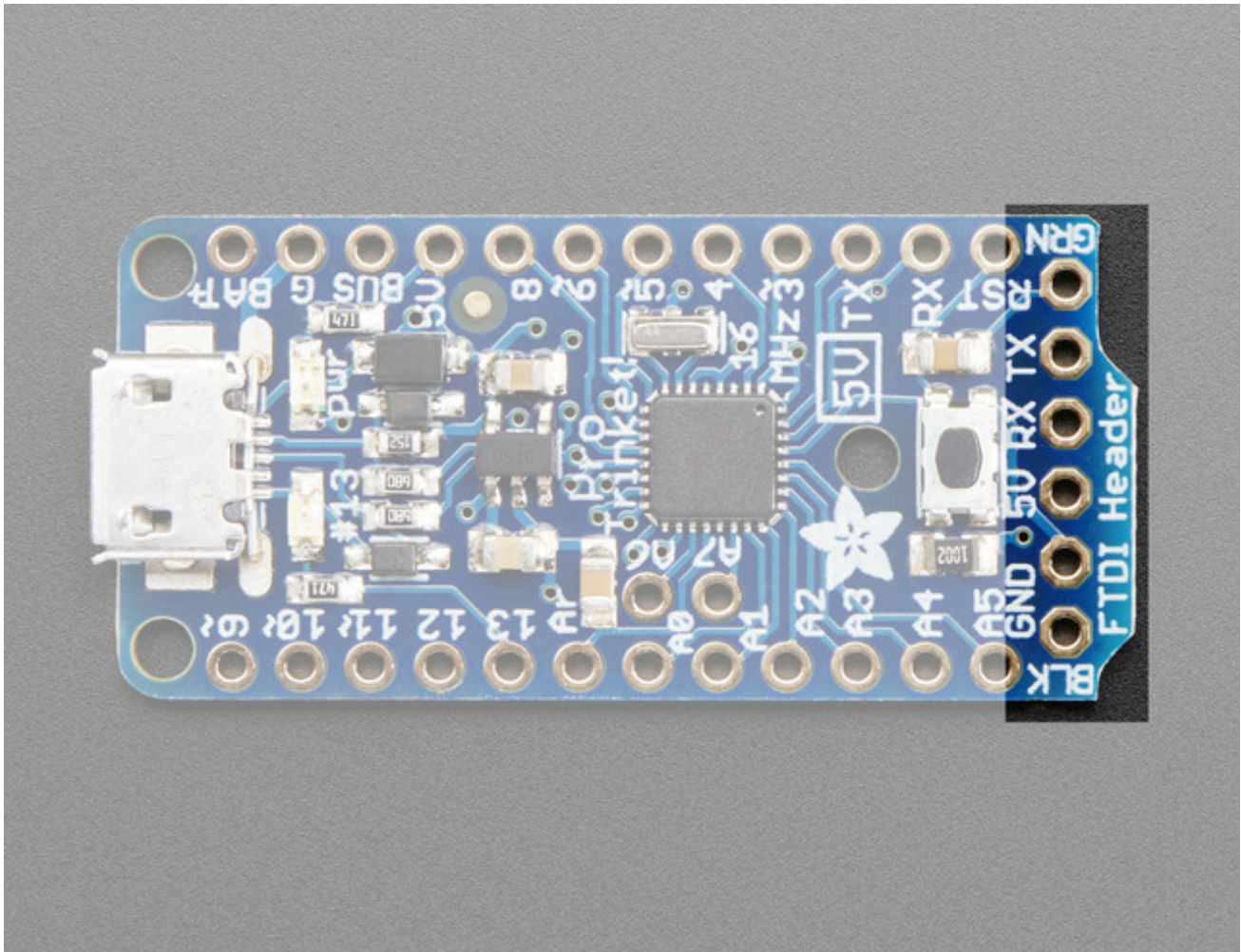

FTDI Breakout

At the bottom is 6 pins in a row that we call the FTDI header. You can use these pins to program the Pro Trinket with an FTDI cable or FTDI Friend. You can also use it for serial debugging.

- **GND** - same as the power ground pins
- **5V** - same as the VBUS pin
- **RX** - same as the RX pin
- **TX** - same as the TX pin
- **RST** - there's a 0.1uF capacitors in between this pin and the Reset pin, so that Arduino-compatible programmers will work correctly with the DTR/RTS-toggle technique

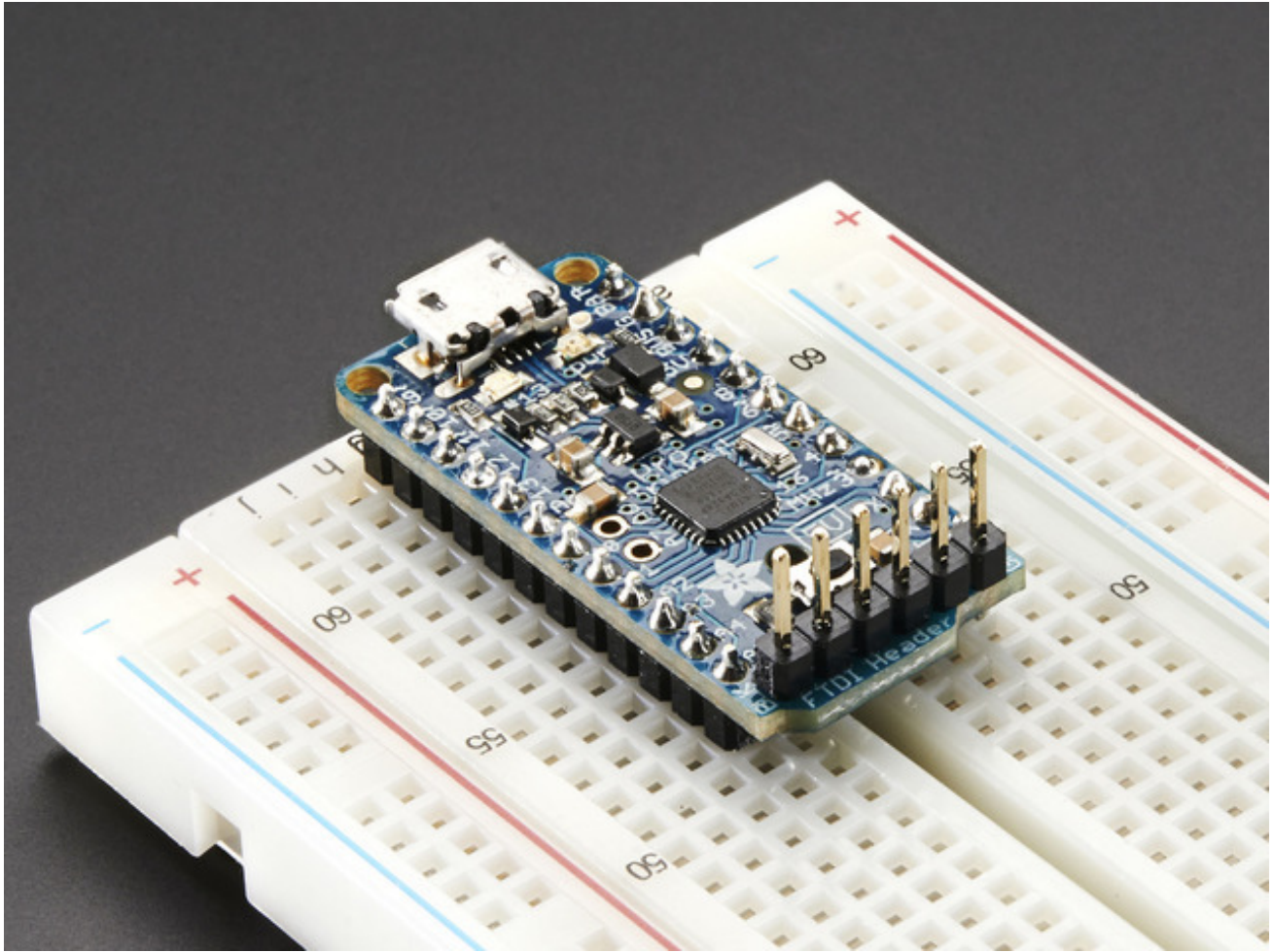

Using the USB Bootloader

About the bootloader

A *bootloader* is a tiny piece of software residing on the microcontroller that that helps load your own code into the remaining space.

One of the challenges with the Pro Trinket is that we wanted to have a built-in USB bootloader, but the ATmega328 doesn't have built-in USB hardware!

So instead, [Frank \(our awesome engineer with mad USB chops\)](http://adafru.it/cDX) (<http://adafru.it/cDX>) created a USB bootloader that combines the elegance of V-USB with the well-supported and tested nature of the USBtinyISP. This bootloader looks just like a USBtinyISP - and since it uses the unique Adafruit VID/PID we own and that we added to `avrdude` so long ago, it works with only very minimal configuraton tweaks. No need to recompile anything, whew!

Then, since we had a little space left in the bootloader area of the chip, we added Optiboot support. You can use *either* the USB connector *or* an FTDI cable so that it acts just like an Arduino Uno for programming, for max flexibility.

The Pro Trinket is smart enough to auto-detect which bootloader you are trying to use. If you plug the USB port in, it will enumerate as a USBtinyISP for USB bootloader. If you plug in FTDI and use the Arduino Uno programming procedure it will use that technique

Please note: you cannot use the Adafruit USB VID/PID for your own non-Trinket products or projects. Purchase a USB VID for yourself at <http://www.usb.org/developers/vendor/>

Pro Trinket USB Drivers for Windows

The cool thing about the bootloader on the Pro Trinket is it just looks like a classic USBtinyISP AVR programmer. This makes it easy to use with AVRdude or Arduino IDE with only minor configuration changes. Before you start, you may need to install the USBtinyISP USB drivers

Drivers are only required for Windows, if you are using a Mac or Linux, drivers are not required!

[For details on installing the drivers for Windows XP, 7, 8 etc... please read this page!](http://adafru.it/cDY) (<http://adafru.it/cDY>)

If you're good at installing drivers, you can just download the [Windows 8 drivers](http://adafru.it/djr) (<http://adafru.it/djr>) or [Windows XP/7/Vista drivers](http://adafru.it/doK) (<http://adafru.it/doK>) by clicking on those links

Download Pro Trinket Drivers for Windows

<http://adafru.it/djr>

Don't forget to plug in the Pro Trinket via a known-good USB cable to start the process. You should see the green power LED lit and the red bootloading LED pulse indicating that the Trinket is ready to start bootloading. If you've programmed the Pro Trinket since getting it, you can always get it back to the bootloader state by pressing the small onboard reset button

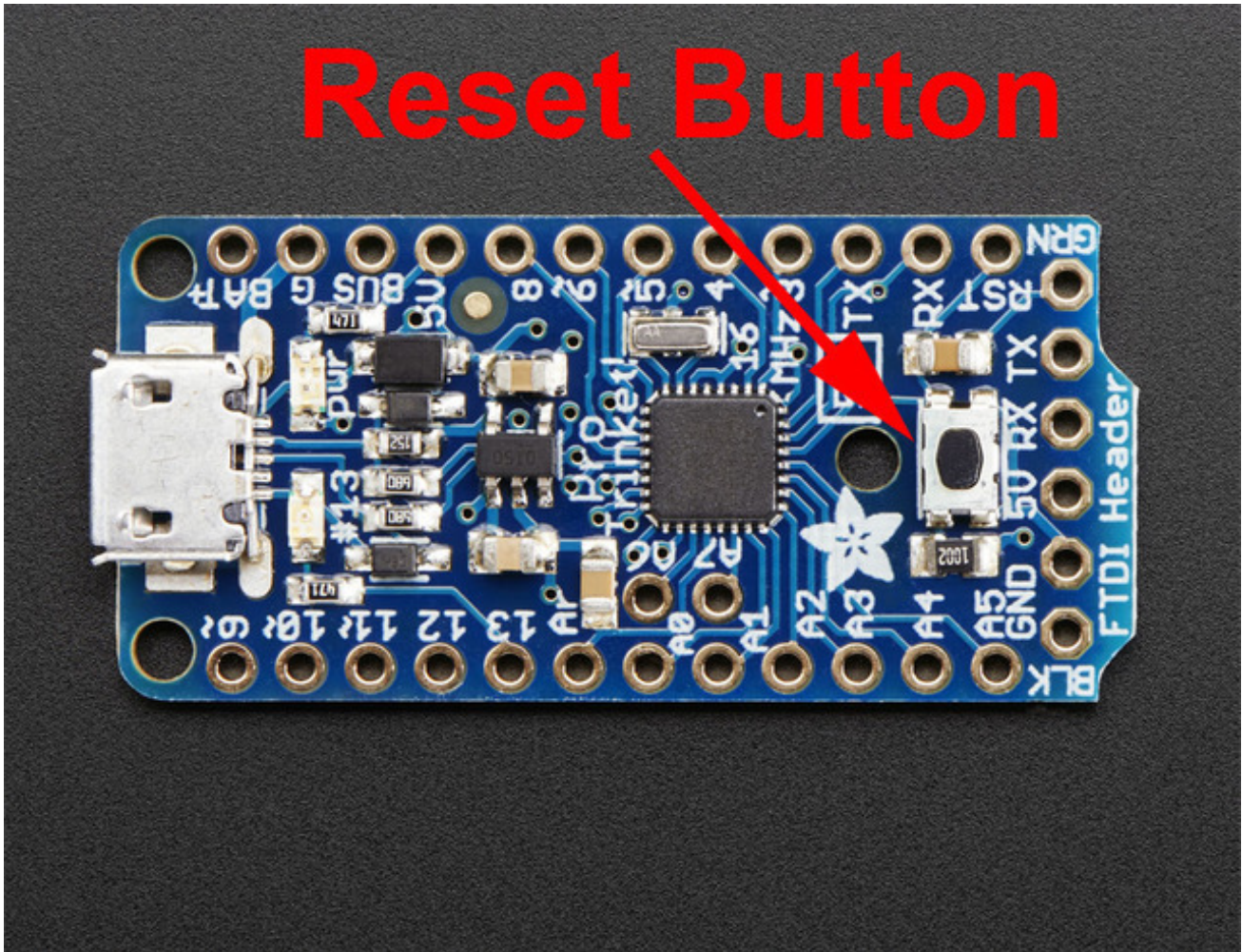

Special Notes on using Pro Trinket with Linux

Pro Trinket is not supported on Linux operating system at this time - try Mac OS or Windows! However, you can try the following - it does work for some computers [\(\)](#)
Linux is fairly picky about who can poke and prod at the USB port. You can always run **avrdude** or **Arduino IDE** as root, which will make sure you have the proper permissions. If you want to be super-cool you can add a *udev* rule which will let any user (who is not root)

connect to the USBtiny driver. That way you don't have to be root all the time!

Check <http://learn.adafruit.com/usbtinyisp/avrdude#for-linux> (<http://adafru.it/cf3>) for what to add to your udev file.

How to start the USB bootloader

Before you try to upload code to the Pro Trinket using the USB bootloader it must be in the Bootloader Mode. That means its listening for a sketch or program to be sent to it

When the Pro Trinket is in bootloader mode, the red LED will be pulsing. Once the red LED stops pulsing, you must press the reset button to re-enter bootloader mode

The Pro Trinket must be connected to a computer via a USB cable to enter bootloader mode. You can enter the bootloader mode by pressing the little button on the board with your fingernail. The bootloader will 'time out' after 10 seconds, so to re-enter the bootloader mode just re-press the button!

Don't press-and-hold the reset button, be sure to press-and-release!

See the video below for what it looks like to plug it in, have the LED pulse in bootloader mode, time out and then press reset to restart the bootloader

Using FTDI Cables

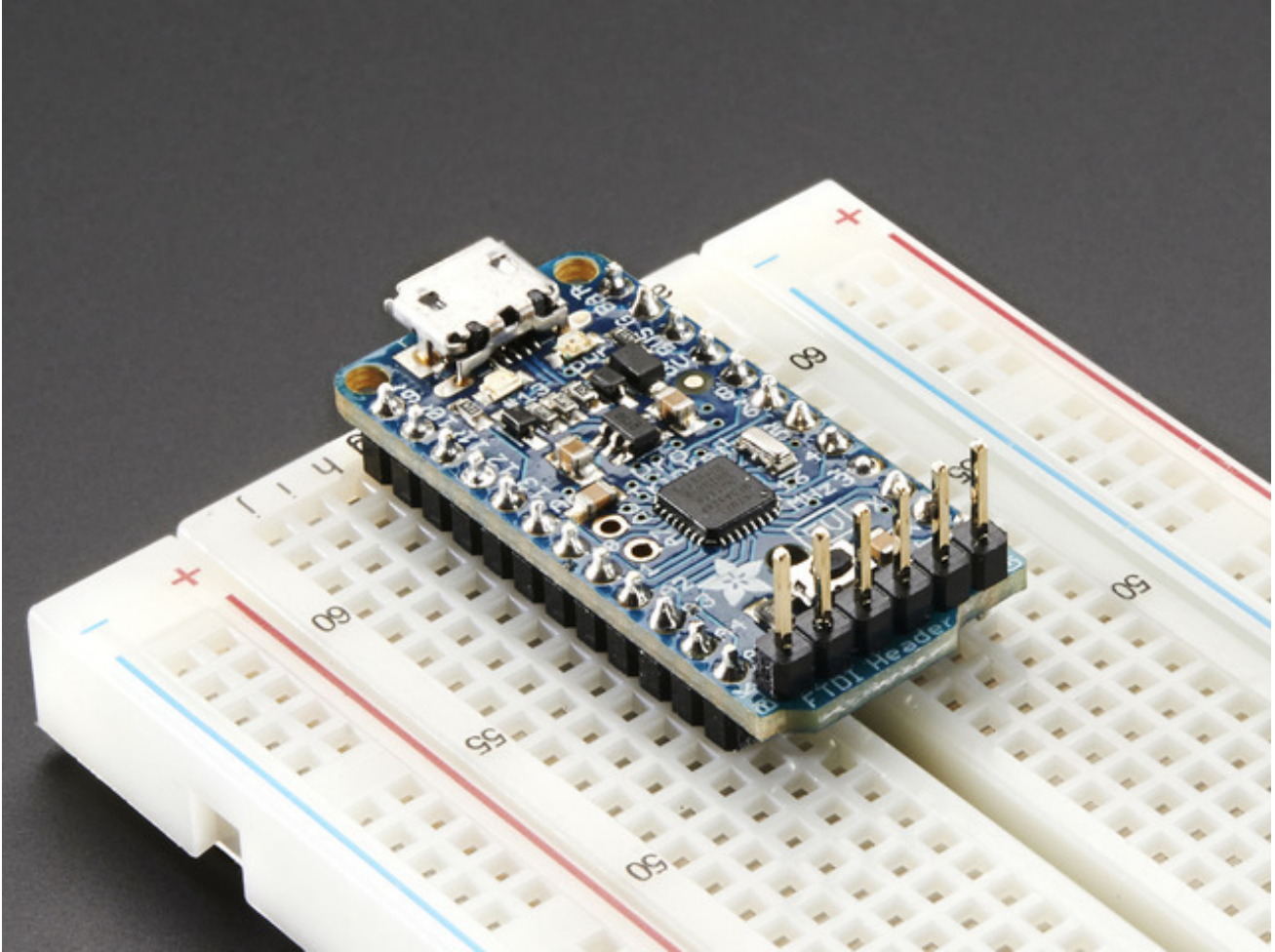



For beginners, we suggest using an FTDI cable for programming and debugging, especially if you aren't simply porting an existing Arduino project to Pro Trinket. Much like many Arduino-compatibles, there's a header for connecting a 'classic' FTDI cable (<http://adafru.it/dNN>) or FTDI friend. (<http://adafru.it/dQa>)

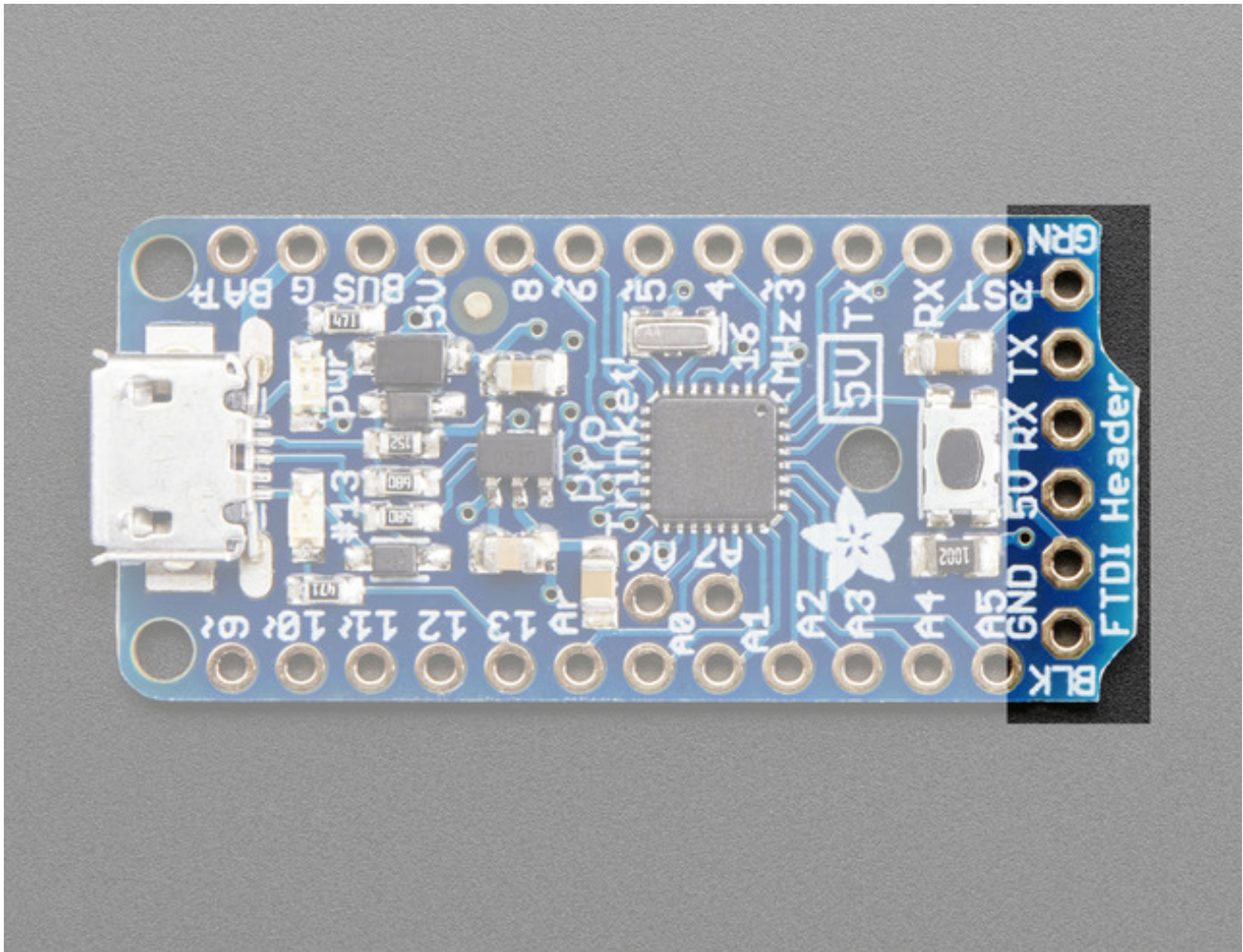

The bootloader on Pro Trinket is **dual USB & FTDI** "optiboot" so you can use either the USB port or the FTDI breakout to upload. However, only the FTDI port allows you to use Serial debugging. So it's a bit of a tradeoff - USB is inexpensive, built-in but requires a button press to start & there's no debugging, FTDI requires an extra cable but has auto-reset and debug console.

Select the correct Board in IDE

Make sure you're selecting the FTDI-program type in the Boards menu!

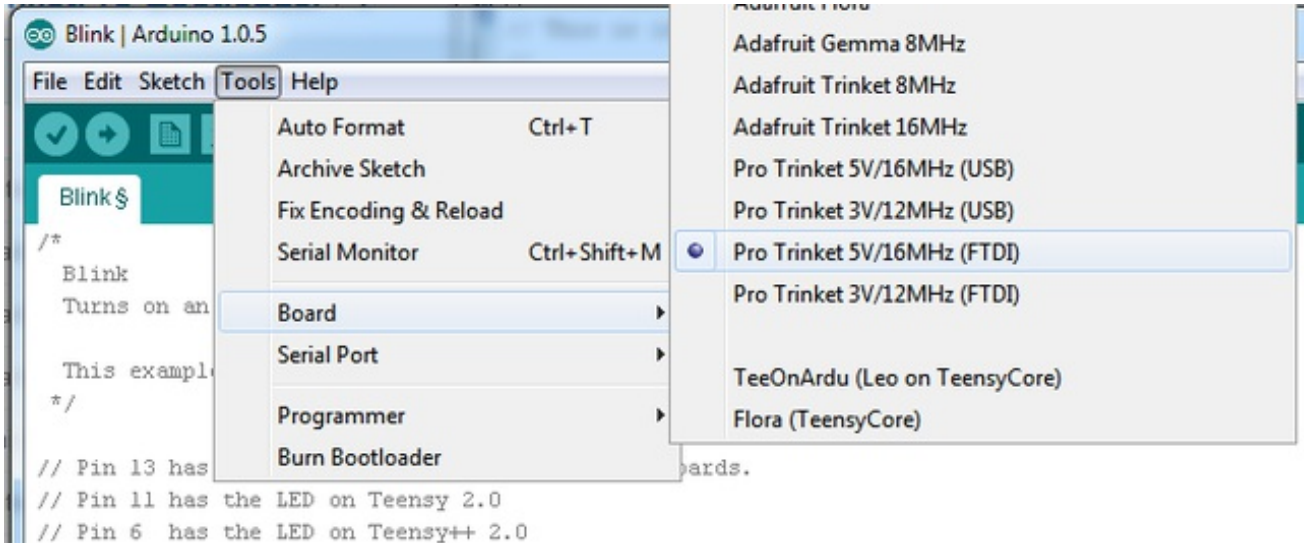

Connect FTDI Friend or Cable

You'll need to solder 6-pin header onto the FTDI breakout first. Match the black wire and green wire with the BLK and GRN markings on the PCB next to the FTDI header

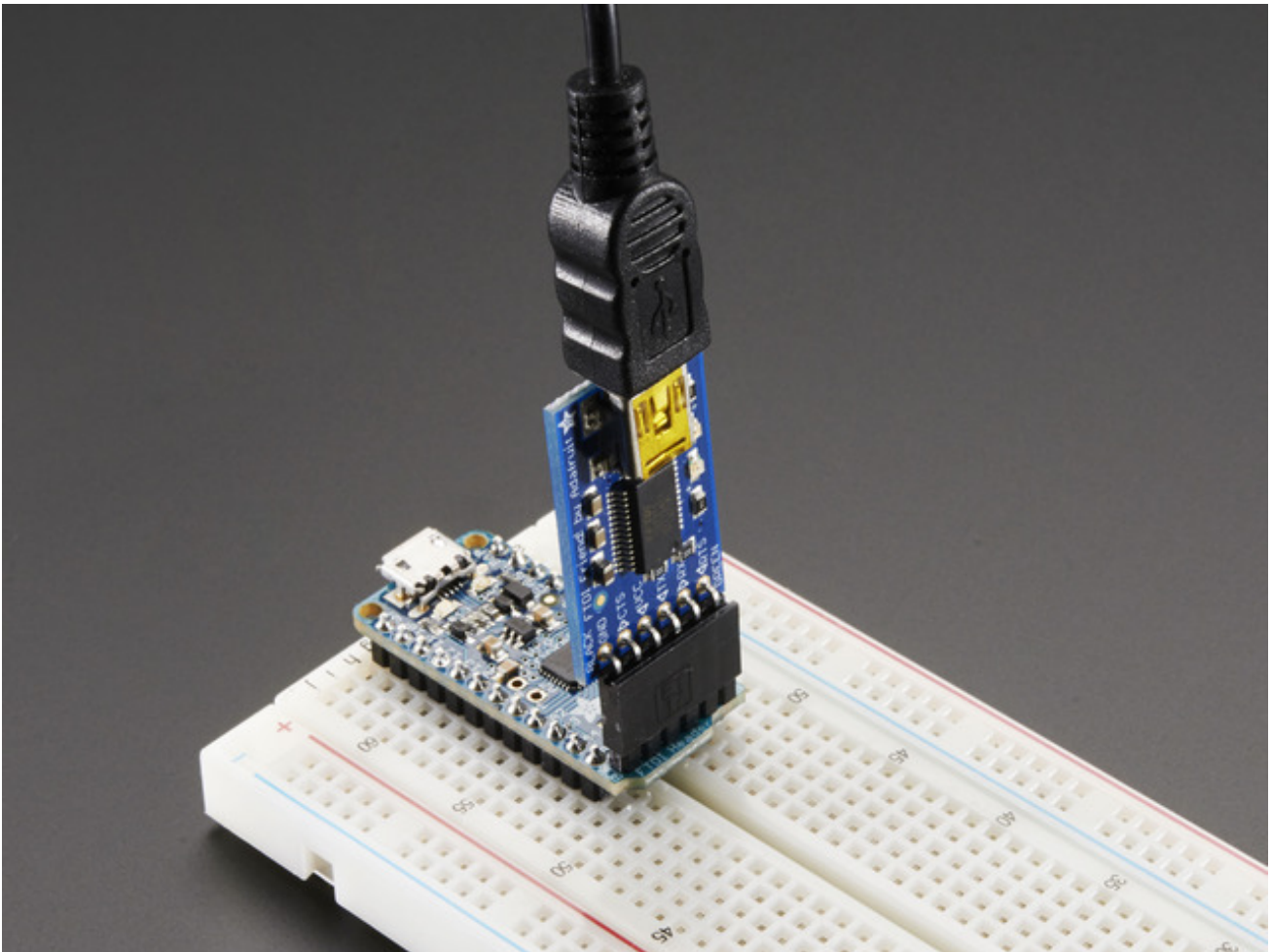

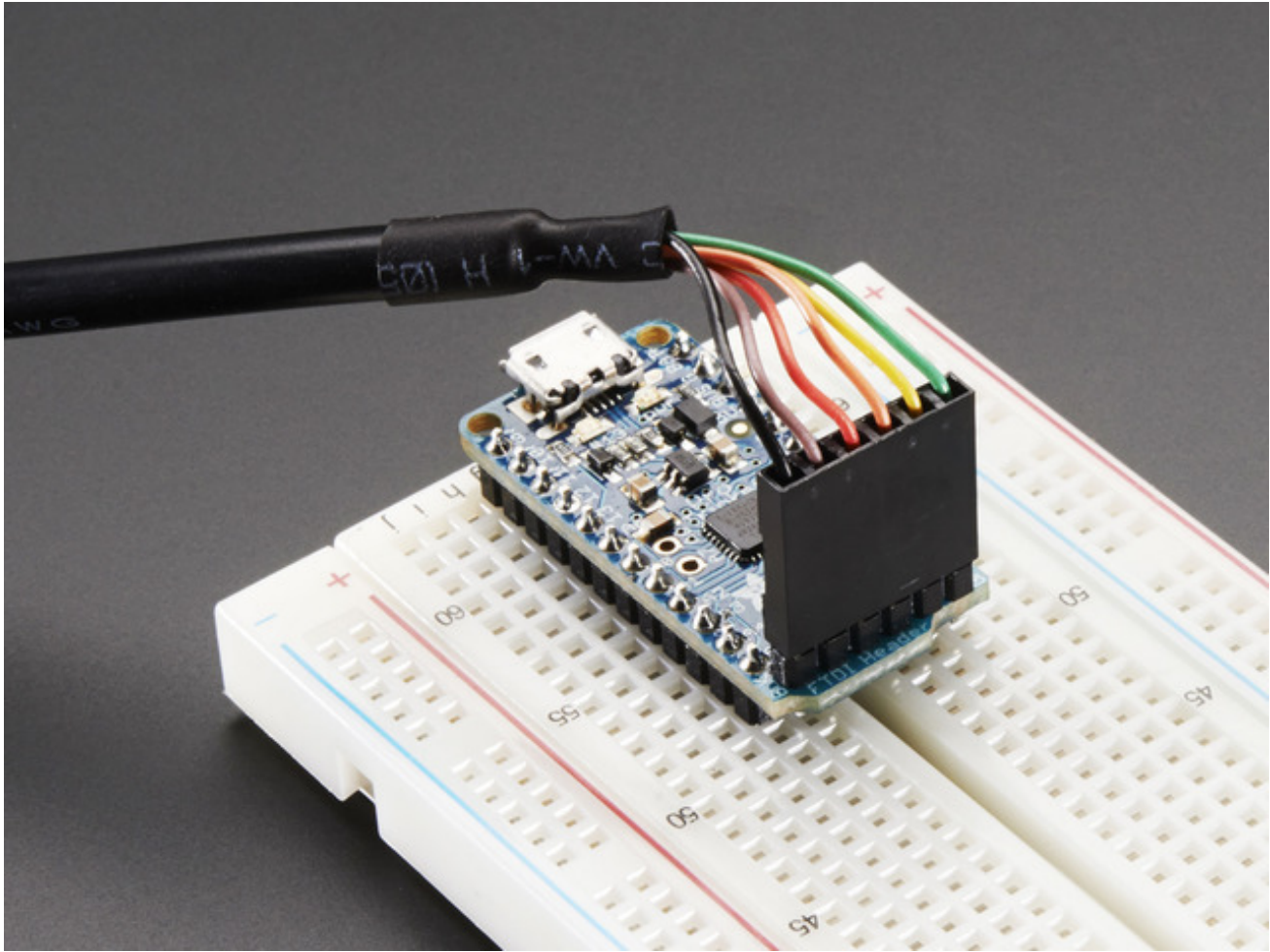

Don't forget you'll need to install FTDI VCP drivers, available from FTDI chip. (<http://adafru.it/ajv>) Then select the COM port from the Tools menu as well, to upload!

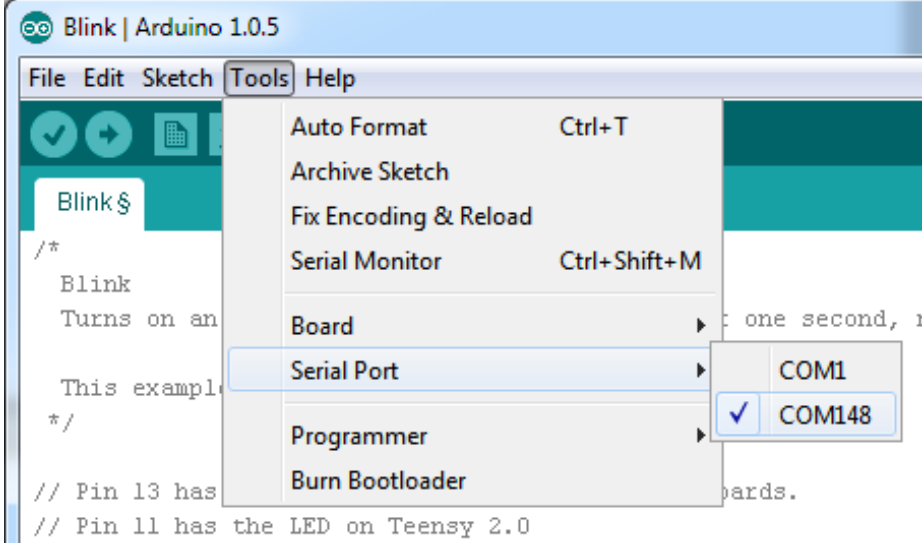

Setting up Arduino IDE

Chances are, you picked up a Trinket because it is programmable with the Arduino IDE. The Pro Trinket uses the same core chip as Arduino UNO, and the 5V Pro Trinket uses the same clock rate and voltage so its pretty much a full Arduino-compatible, just smaller!

The only changes you may have to consider when adapting Arduino sketches are:

- Pins #2 and #7 are not available
- The onboard 5V regulator can provide 150mA output, not 800mA out
- You cannot plug shields directly into the Pro Trinket
- There is no Serial-to-USB chip onboard. This is to keep the Pro Trinket small and inexpensive, you can use any FTDI cable to connect to the FTDI port for a Serial connection
- The bootloader on the Pro Trinket use 4KB of FLASH so the maximum sketch size is 28,672 bytes. The bootloader does not affect RAM usage.

Even though Trinket has a USB connector, it does not have a "Serial Console" capability, so you cannot use Serial to send and receive data to/from a computer with a seperate FTDI Cable!

The Fast Way

If you don't want to modify an existing Arduino IDE install, you can simply download our ready-to-go and tested Flora/Gemma/Trinket-ified v1.05 right here:

Download Adafruit IDE v1.05 for
Mac

<http://adafru.it/dRo>

Download Adafruit IDE v1.05 for
Windows

<http://adafru.it/dRr>

Download Adafruit IDE v1.0.5 for
Linux (32-bit)

<http://adafru.it/dXa>

Download Adafruit IDE v1.0.5 for

Be sure to extract the contents of the zip file. The IDE will not execute properly from a compressed folder.

Mac OSX

If you're using Mac OS Mavericks you will need to update the setting to permit running Arduino IDE

1. Open System Preferences and select the Security and Privacy icon.
2. Select the 'General' tab
3. Click the Lock Icon and Login
4. Change "Allow Apps Downloaded From": to "Anywhere"
5. Open the downloaded IDE.
6. Go back to the Security preferences and change the selection back to "Mac App Store and identified developers"
7. You only need to go through this procedure once. Mavericks will remember that it's OK to run the app.

Linux

When installing the Linux version of the modified Arduino IDE you will want to add a udev rule so the IDE can be run as a non-root user and access the USB ports. If you're using Ubuntu you can follow these steps to install an updated udev rule:

```
wget https://github.com/adafruit/Trinket_Arduino_Linux/raw/master/adafruit-trinket.rules
sudo cp adafruit-trinket.rules /etc/udev/rules.d/
sudo reload udev
```

If you're not using Ubuntu, you might need to modify the udev rule to change the group to something other than "dialout". [Check out this page \(http://adafru.it/dXc\)](http://adafru.it/dXc) for more tips on udev configuration rules.

NOTE: When using Trinket in the Linux Arduino IDE make sure to change the programmer to "USBtinyISP" under the Tools -> Programmer menu!

The Slow Way

Step 0. Install Arduino IDE

Pro Trinket support is not native to the Arduino IDE but, luckily, adding it takes only a few

minutes and you only have to do it once! This tutorial will base the IDE off of v1.0.5 which is current at time of writing. You can try later versions but v1.0.5 is at least guaranteed to work

Adding Pro Trinket support does not affect any other boards that are affected so you can continue to use the IDE with any Arduino board currently supported.

Linux note: You can find instructions for manually modifying the Arduino IDE to support Trinket in the [README of the Trinket Arduino Linux github repository \(http://adafru.it/dXd\)](http://adafru.it/dXd).

Step 1. Download and add Pro Trinket folder

Download the following file by pressing the button.

Download Pro Trinket hardware
add-on

<http://adafru.it/dRq>

Unzip it and move the **hardware** folder from the zip file and place it into to your Arduino *sketchbook* folder. Your sketchbook folder is the folder where the Arduino IDE stores your sketches. This folder is automatically created by the IDE when you install it. If this is your first time using the Arduino IDE, it will be empty!

On Linux machines, the folder is named "Sketchbook" and it is typically located in /home/[username]

On Windows and Macintosh machines, the default name of the folder is "Arduino" and is located in your Documents folder.

This is a common source of confusion on Windows and Mac machines, your sketchbook folder is not named "sketchbook" it is named "Arduino"!

Now you can start (or restart the the IDE) and check the **Tools->Board** menu, you should see the four new entries for Pro Trinket:

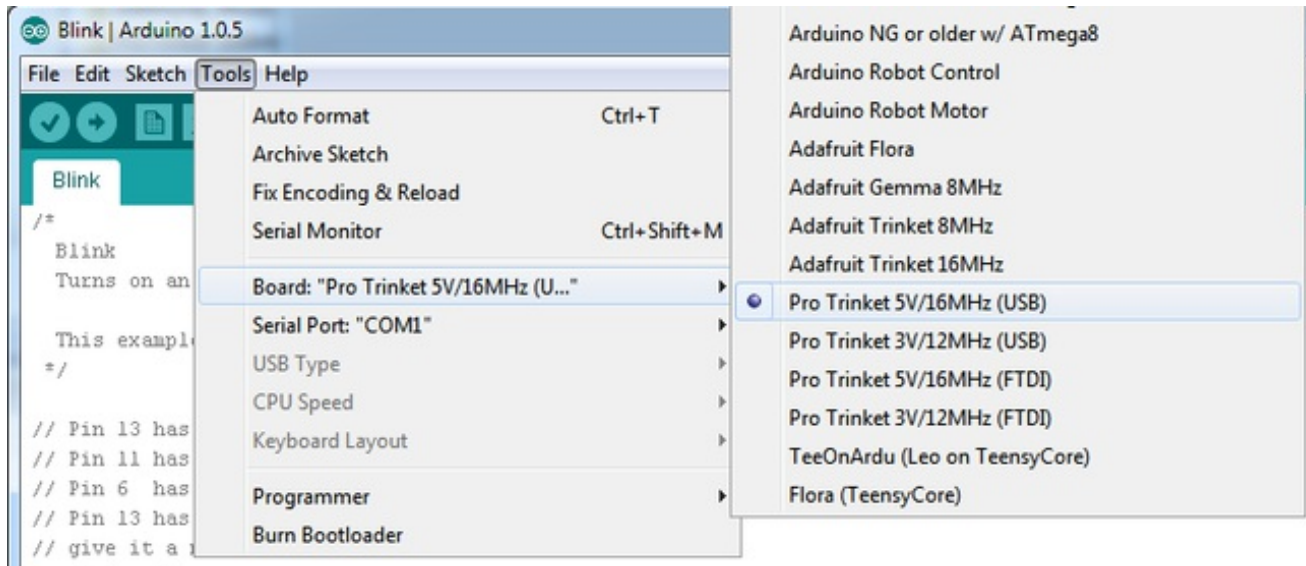

OK you are done! (Not so bad, eh?)

Blink!

OK let's practice uploading a sketch by uploading the classic Blink sketch with the USB bootloader. This program will blink the onboard red LED that is connected to pin #13.

The sketch is in **File->Examples->Basics->Blink**

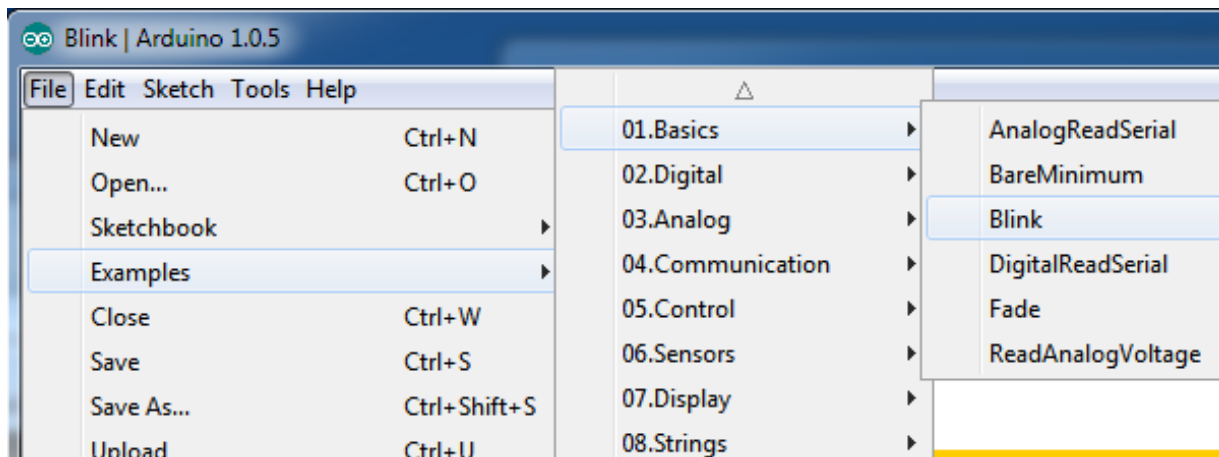

If you are using Linux you may have to be "root" running the Arduino program to have access to the USB port

Select the **Pro Trinket 5V/16MHz (USB)** or **Pro Trinket 3V/12MHz (USB)** board from the **Tools->Board** menu

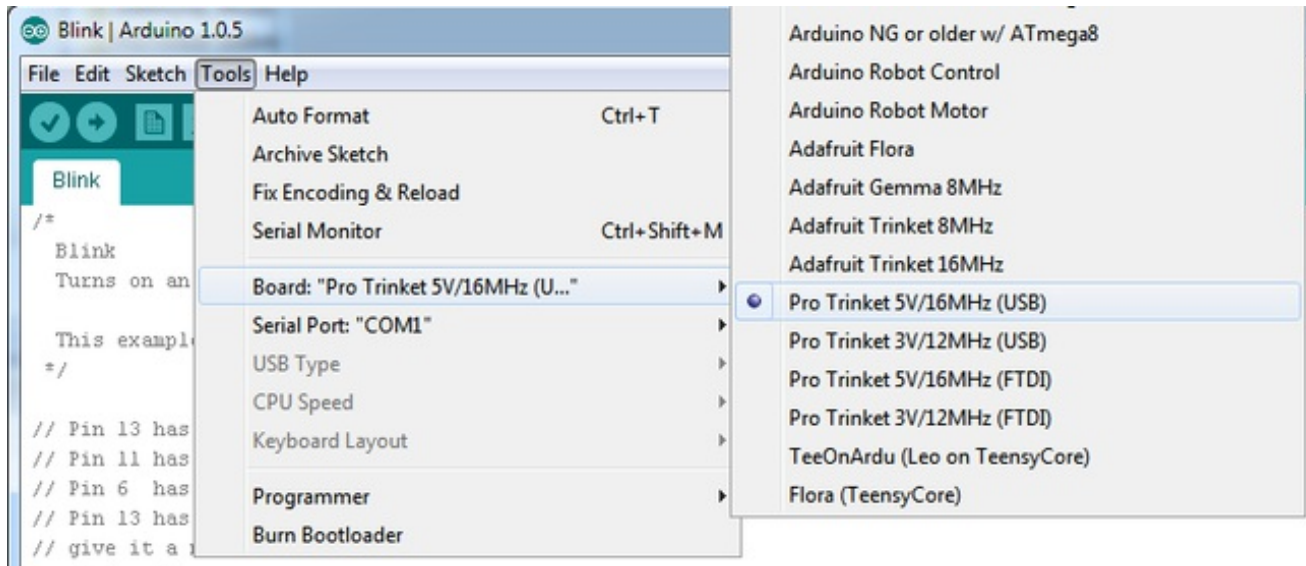

Plug in the Trinket, make sure you see the green LED lit (power good) and the red LED pulsing. Press the button if the red LED is not pulsing, to get into bootloader mode.

Click the **Upload** button (or select **File->Upload**)

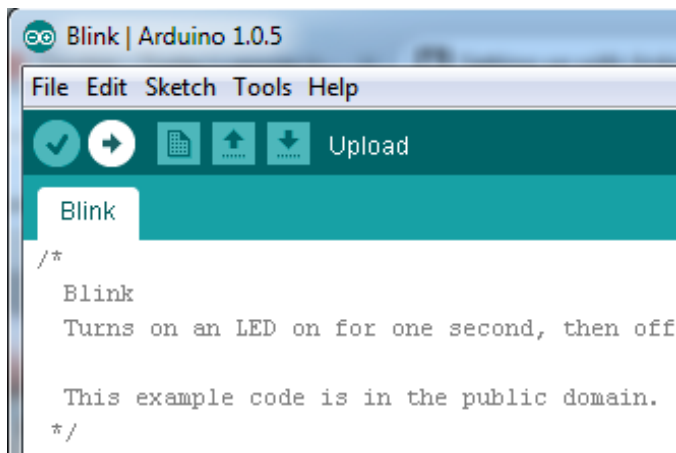

If everything goes smoothly you should see the following (no red error messages) and of course, the red LED on the trinket will blink on/off once a second

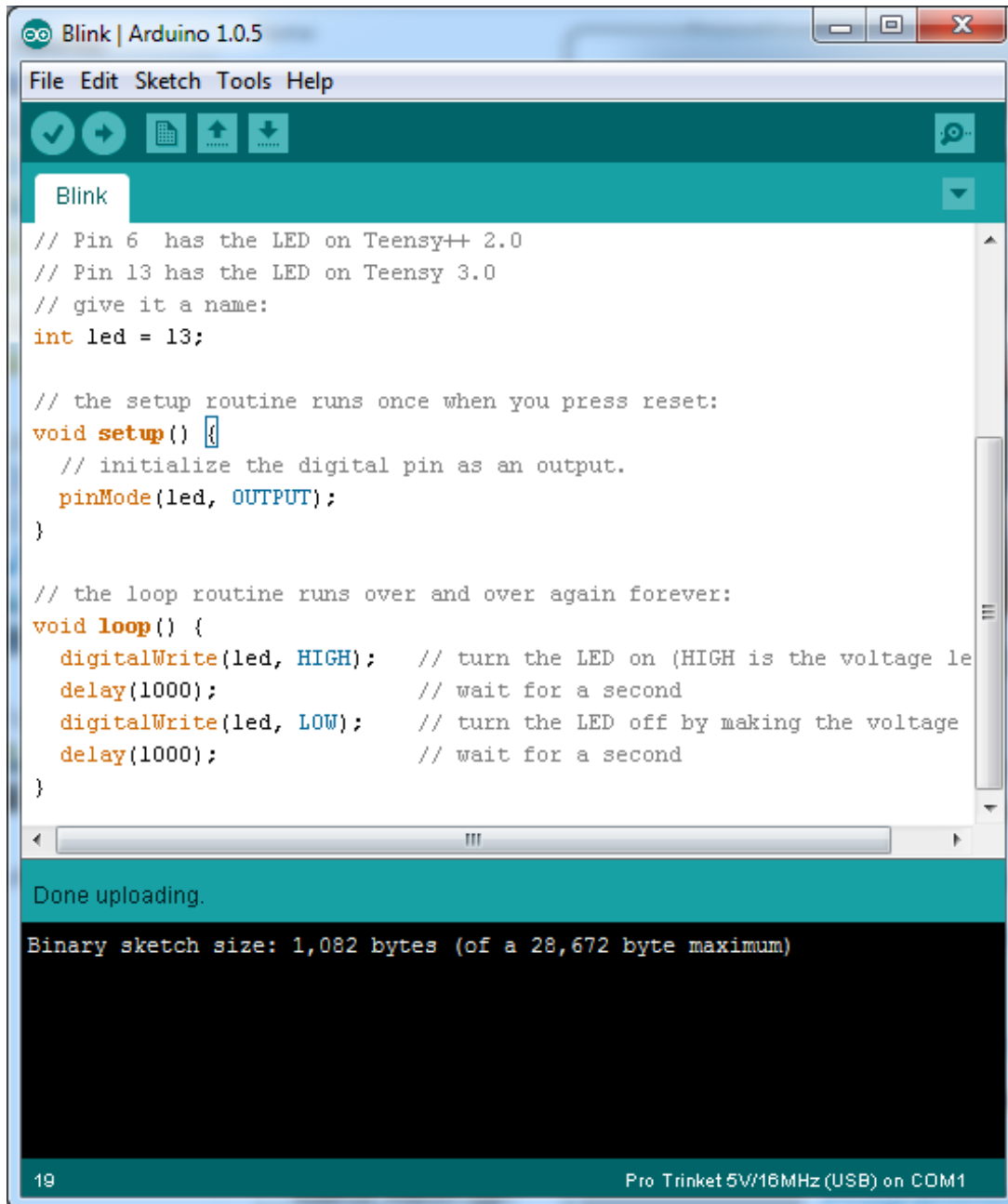

Something Went Wrong!

If you get the error message `avrdude: Error: Could not find USBtiny device (0x1781/0xc9f)`

That means the bootloader wasn't active. Make sure to press the button on the Trinket to activate the bootloader *before* clicking the Upload button. Also, check that you see the red pulsing LED on #13 that indicates the USB bootloader enumerated to your computer

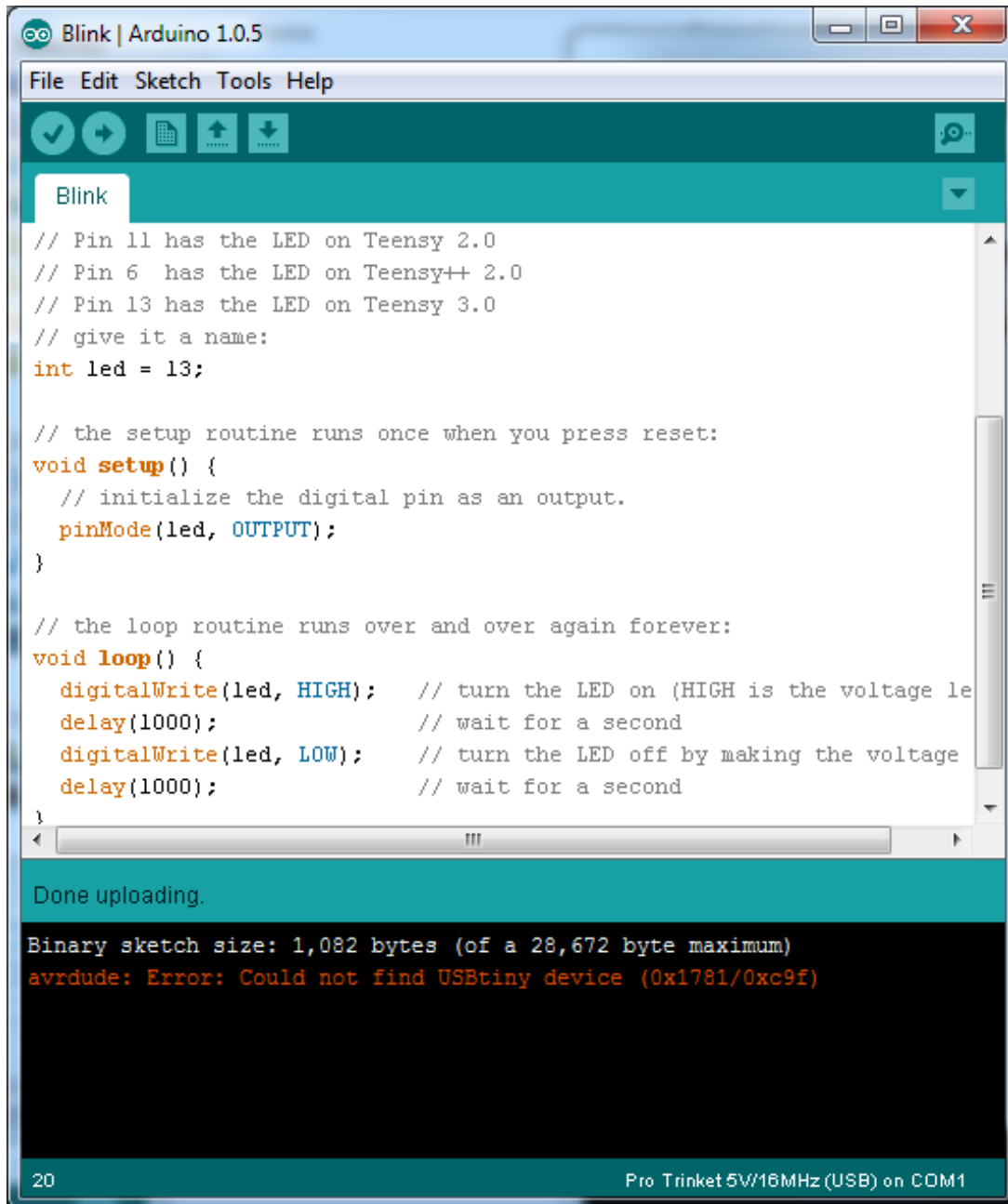

Also, don't forget to install the Windows driver if you're using windows!

Hints for Arduino-compatibility

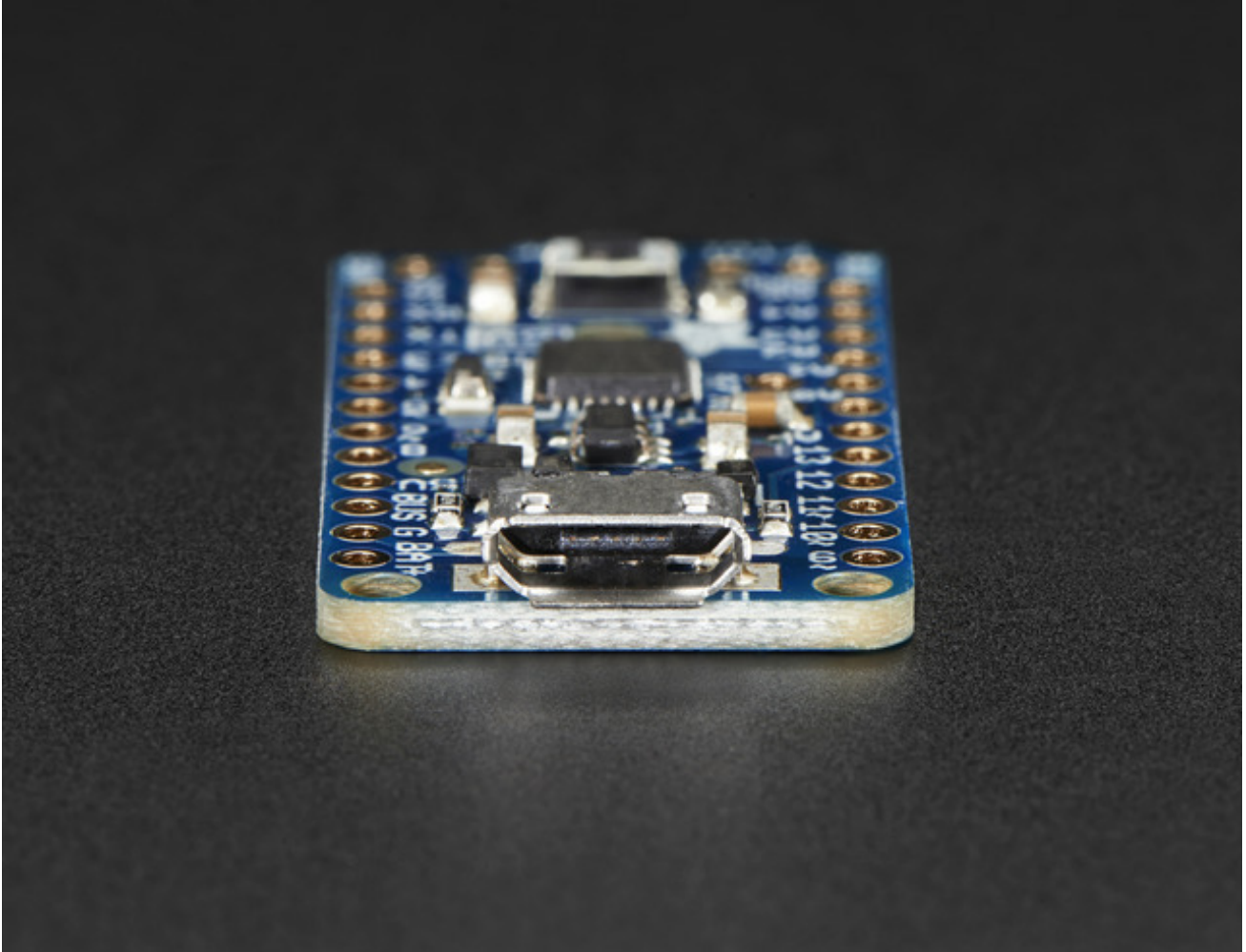

The Pro Trinket uses the Atmega328P chip, which is the same core chip in the Arduino UNO/Duemilanove/Mini/etc. It's the 'classic' Arduino chip! So you'll be happy to hear that not only is Pro Trinket programmable using the Arduino IDE as you already set up, but 99% of Arduino projects will work out of the box!

The Pro Trinket 5V runs at 16MHz, just like the Uno. The Pro Trinket 3V runs at 12MHz, which we suggest for 'power users' who want a 3V Arduino-compatible and don't mind its a bit slower at 12MHz.

The only changes you may have to consider when adapting Arduino sketches are:

- Pins #2 and #7 are not available
- The onboard 5V regulator can provide 150mA output, not 800mA out
- You cannot plug shields directly into the Pro Trinket
- There is no Serial-to-USB chip onboard. This is to keep the Pro Trinket small and inexpensive, you can use any FTDI cable to connect to the FTDI port for a Serial connection

- The 3V Pro Trinket runs at 12MHz not 16MHz so its a bit slower.
- The bootloader on the Pro Trinket use 4KB of FLASH so the maximum sketch size is 28,672 bytes. The bootloader does not affect RAM usage.

Downloads

Windows Driver

Please note a driver is not required for Mac or Linux. And the driver does not appear as a 'COM' port! It will show up as a 'USBtinyISP' device

Download Signed Pro Trinket
Driver (Win XP/7/8)

<http://adafru.it/djr>

Source code

[Original code for the Pro Trinket bootloader on github \(http://adafru.it/dRt\)](http://adafru.it/dRt)

We do not offer any support for this code, it is released as-is!

Please note: you cannot use the Adafruit USB VID/PID for your own non-Trinket/Gemma products or projects. Purchase a USB VID for yourself at <http://www.usb.org/developers/vendor/>

Schematics

Pro Trinket 5V 16MHz:

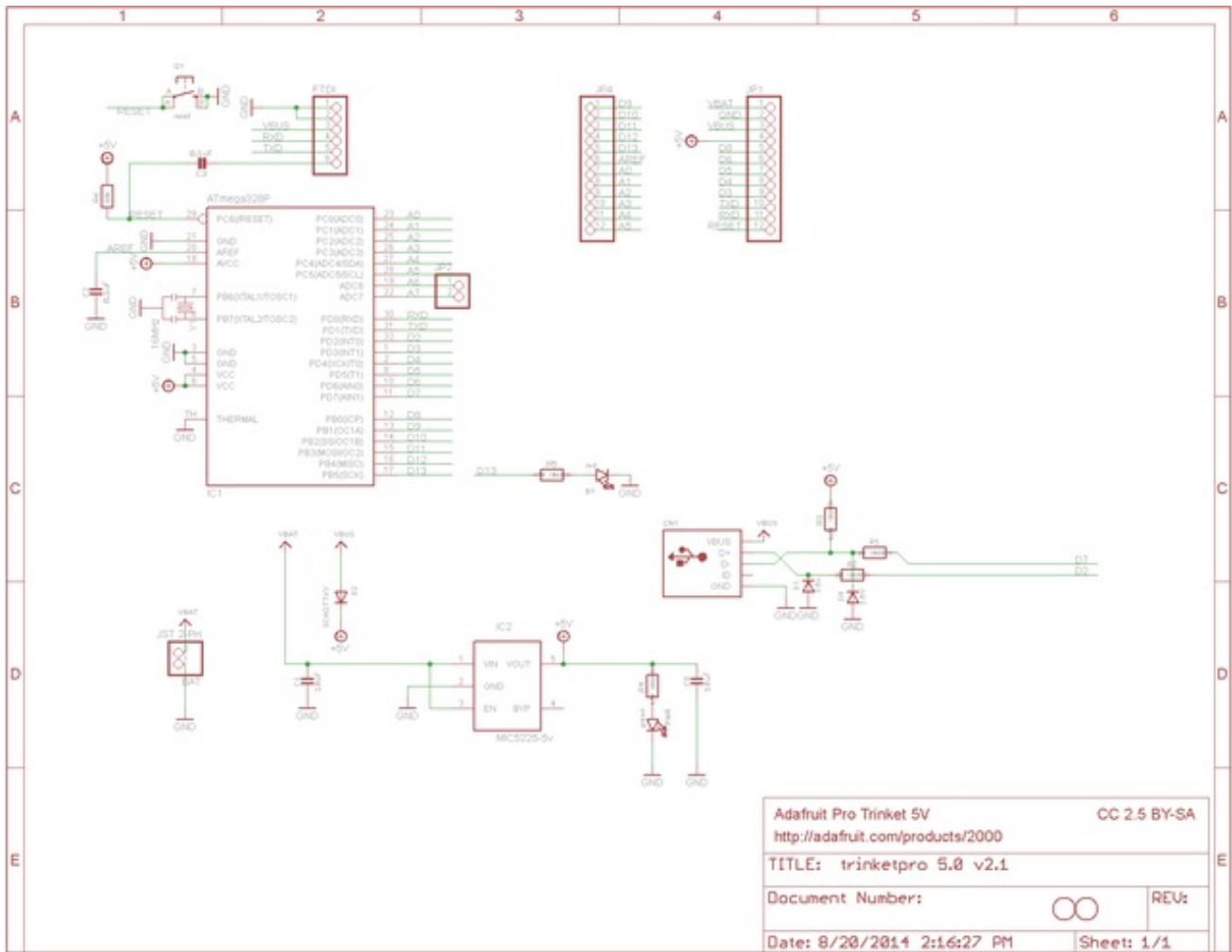

Pro Trinket 3V @ 12MHz

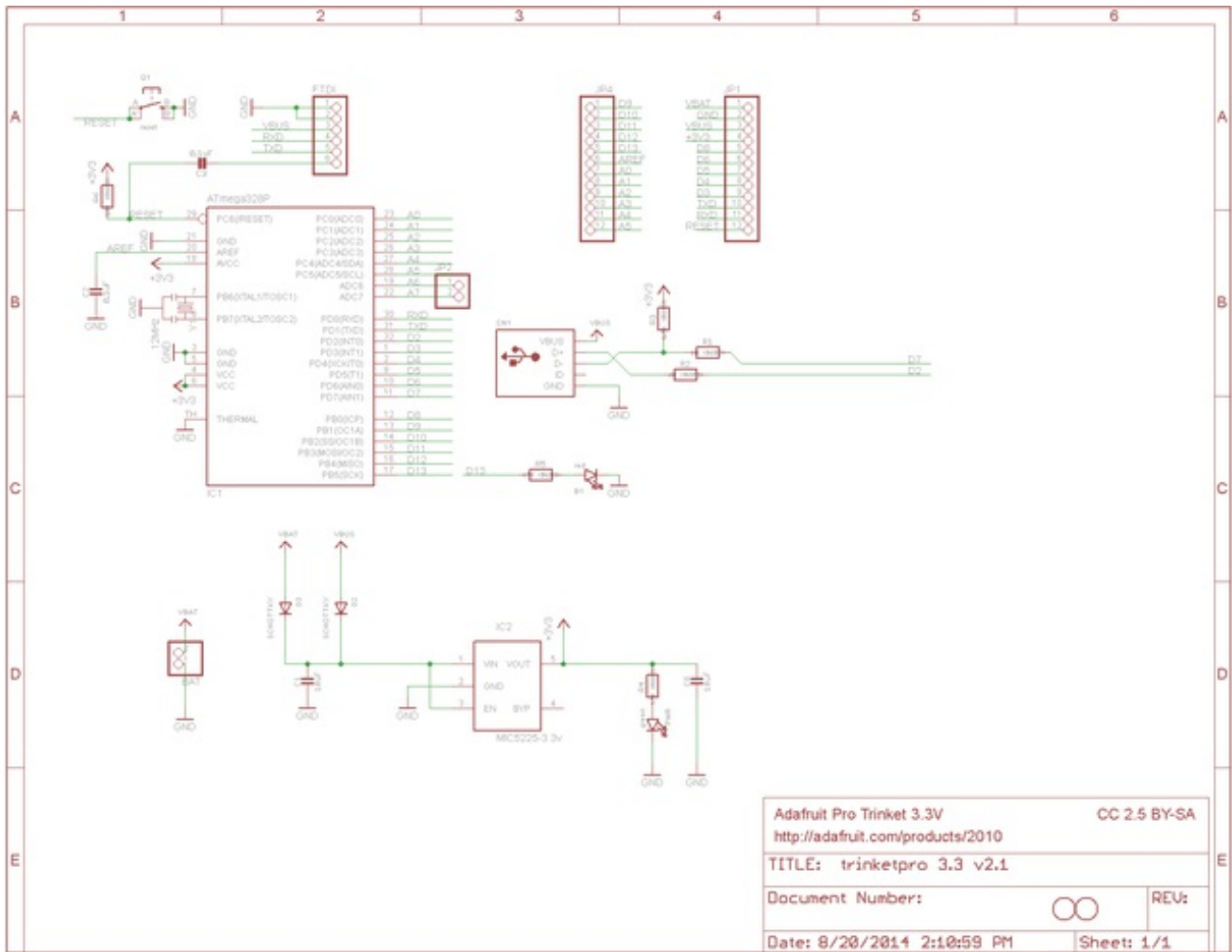

Fabrication print, dimensions in inches (same for both 3V and 5V)

