



CY7C1470V33
CY7C1472V33
CY7C1474V33

72-Mbit (2M × 36/4M × 18/1M × 72) Pipelined SRAM with NoBL™ Architecture

Features

- Pin compatible and functionally equivalent to ZBT
- Supports 200 MHz Bus operations with zero wait states
 - Available speed grades are 200 and 167 MHz
- Internally self timed output buffer control to eliminate the need to use asynchronous OE
- Fully registered (inputs and outputs) for pipelined operation
- Byte write capability
- Single 3.3 V power supply
- 3.3 V/2.5 V I/O power supply
- Fast clock-to-output time
 - 3.0 ns (for 200 MHz device)
- Clock enable ($\overline{\text{CEN}}$) pin to suspend operation
- Synchronous self timed writes
- CY7C1470V33 available in JEDEC-standard Pb-free 100-pin TQFP, and non Pb-free 165-ball FBGA package. CY7C1472V33 available in JEDEC-standard Pb-free 100-pin TQFP. CY7C1474V33 available in non Pb-free 209-ball FBGA package
- IEEE 1149.1 JTAG boundary scan compatible
- Burst capability – linear or interleaved burst order
- “ZZ” sleep mode option and stop clock option

Functional Description

The CY7C1470V33, CY7C1472V33, and CY7C1474V33 are 3.3 V, 2M × 36/4M × 18/1M × 72 synchronous pipelined burst SRAMs with No Bus Latency™ (NoBL™) logic, respectively. They are designed to support unlimited true back-to-back read/write operations with no wait states. The CY7C1470V33, CY7C1472V33, and CY7C1474V33 are equipped with the advanced (NoBL) logic required to enable consecutive read/write operations with data being transferred on every clock cycle. This feature dramatically improves the throughput of data in systems that require frequent write/read transitions. The CY7C1470V33, CY7C1472V33, and CY7C1474V33 are pin compatible and functionally equivalent to ZBT devices.

All synchronous inputs pass through input registers controlled by the rising edge of the clock. All data outputs pass through output registers controlled by the rising edge of the clock. The clock input is qualified by the clock enable ($\overline{\text{CEN}}$) signal, which when deasserted suspends operation and extends the previous clock cycle.

Write operations are controlled by the byte write selects ($\text{BW}_a\text{--}\text{BW}_h$ for CY7C1474V33, $\text{BW}_a\text{--}\text{BW}_d$ for CY7C1470V33 and $\text{BW}_a\text{--}\text{BW}_b$ for CY7C1472V33) and a write enable (WE) input. All writes are conducted with on-chip synchronous self timed write circuitry.

Three synchronous chip enables ($\overline{\text{CE}}_1$, CE_2 , $\overline{\text{CE}}_3$) and an asynchronous output enable ($\overline{\text{OE}}$) provide for easy bank selection and output tristate control. In order to avoid bus contention, the output drivers are synchronously tristated during the data portion of a write sequence.

For a complete list of related documentation, click [here](#).

Selection Guide

Description	200 MHz	167 MHz	Unit
Maximum access time	3.0	3.4	ns
Maximum operating current	500	450	mA
Maximum CMOS standby current	120	120	mA

Errata: For information on silicon errata, see [Errata on page 35](#). Details include trigger conditions, devices affected, and proposed workaround.

Logic Block Diagram – CY7C1470V33

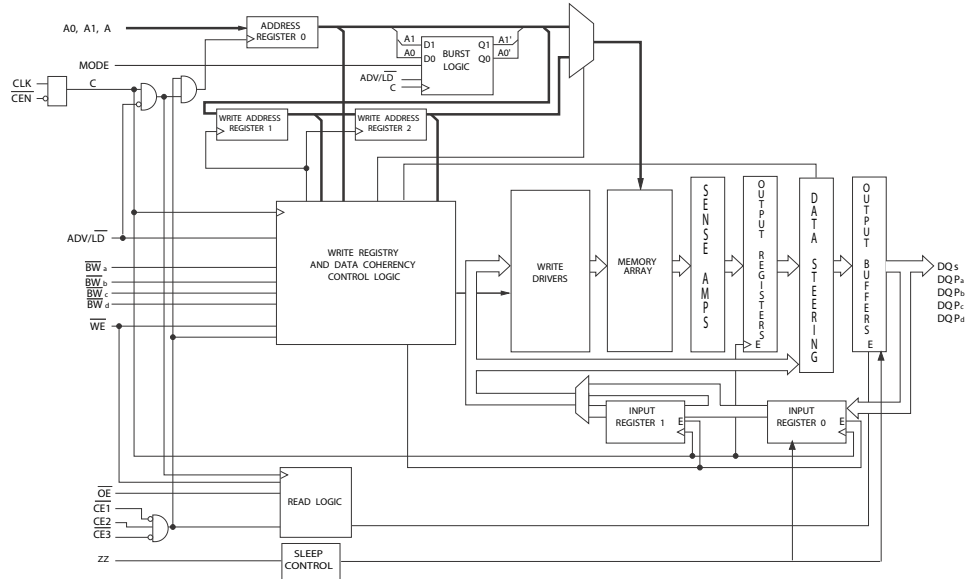

Logic Block Diagram – CY7C1472V33

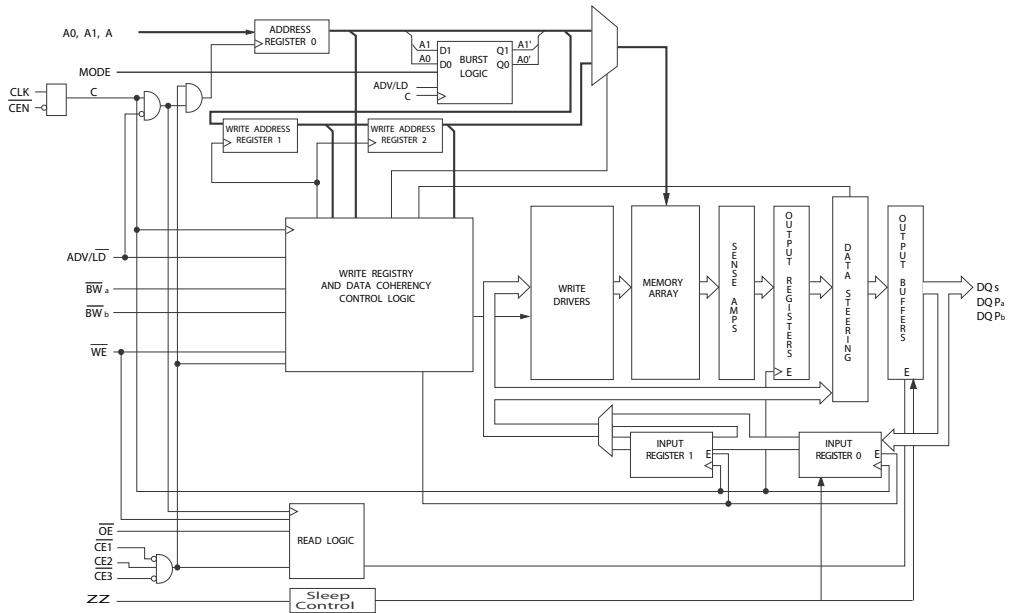

Logic Block Diagram – CY7C1474V33

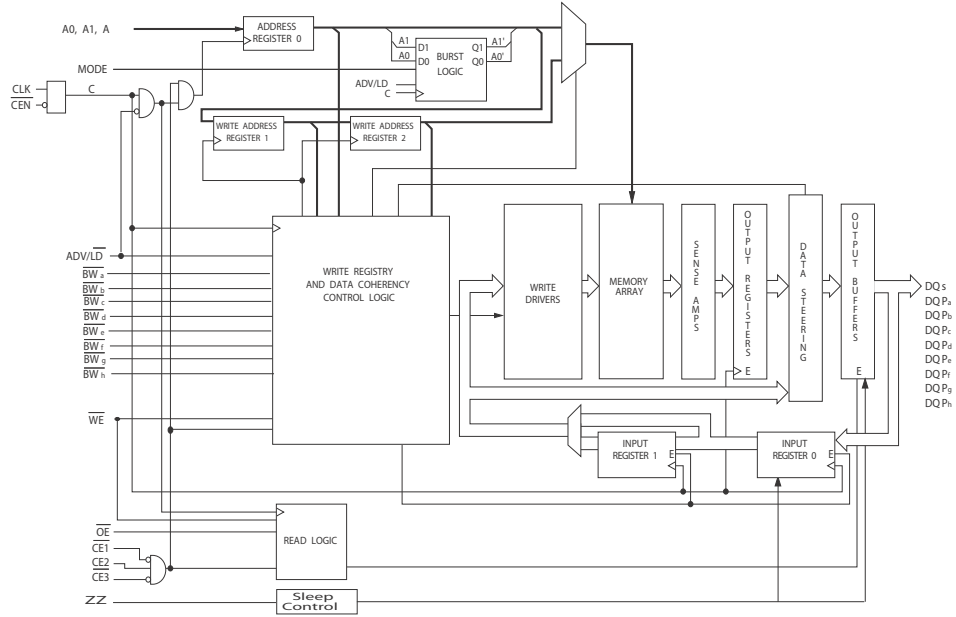

Contents

Pin Configurations	5	Scan Register Sizes	21
Pin Definitions	8	Identification Codes	21
Functional Overview	10	Boundary Scan Exit Order	22
Single Read Accesses	10	Boundary Scan Exit Order	23
Burst Read Accesses	10	Maximum Ratings	24
Single Write Accesses	10	Operating Range	24
Burst Write Accesses	11	Neutron Soft Error Immunity	24
Sleep Mode	11	Electrical Characteristics	24
Interleaved Burst Address Table	11	Capacitance	25
Linear Burst Address Table	11	Thermal Resistance	25
ZZ Mode Electrical Characteristics	11	AC Test Loads and Waveforms	26
Truth Table	12	Switching Characteristics	27
Partial Write Cycle Description	13	Switching Waveforms	28
Partial Write Cycle Description	13	Ordering Information	30
Partial Write Cycle Description	14	Ordering Code Definitions	30
IEEE 1149.1 Serial Boundary Scan (JTAG)	15	Package Diagrams	31
Disabling the JTAG Feature	15	Acronyms	34
Test Access Port (TAP)	15	Document Conventions	34
PERFORMING A TAP RESET	15	Units of Measure	34
TAP REGISTERS	15	Errata	35
TAP Instruction Set	15	Part Numbers Affected	35
TAP Controller State Diagram	17	Product Status	35
TAP Controller Block Diagram	18	Ram9 NoBL ZZ Pin Issues Errata Summary	35
TAP Timing Diagram	18	Document History Page	36
TAP AC Switching Characteristics	19	Sales, Solutions, and Legal Information	40
3.3 V TAP AC Test Conditions	20	Worldwide Sales and Design Support	40
3.3 V TAP AC Output Load Equivalent	20	Products	40
2.5 V TAP AC Test Conditions	20	PSoC@Solutions	40
2.5 V TAP AC Output Load Equivalent	20	Cypress Developer Community	40
TAP DC Electrical Characteristics		Technical Support	40
and Operating Conditions	20		
Identification Register Definitions	21		

Pin Configurations

Figure 1. 100-pin TQFP (14 × 20 × 1.4 mm) pinout ^[1]

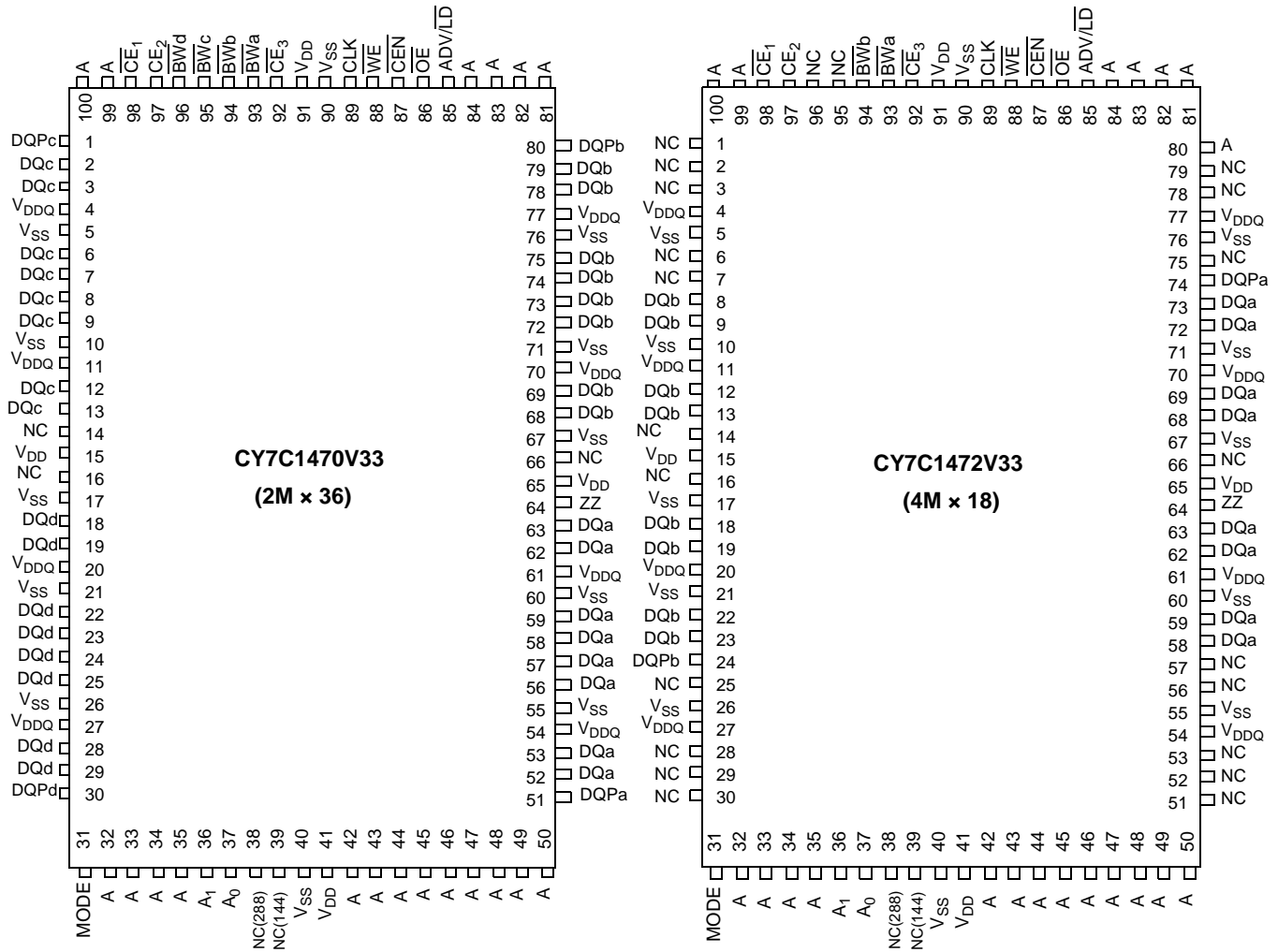

Note

1. **Errata:** The ZZ pin (Pin 64) needs to be externally connected to ground. For more information, see [Errata on page 35](#).

Pin Configurations (continued)

Figure 2. 165-ball FBGA (15 × 17 × 1.4 mm) pinout [2]

CY7C1470V33 (2M × 36)

	1	2	3	4	5	6	7	8	9	10	11
A	NC/576M	A	\overline{CE}_1	\overline{BW}_c	\overline{BW}_b	\overline{CE}_3	\overline{CEN}	ADV/LD	A	A	NC
B	NC/1G	A	CE2	\overline{BW}_d	\overline{BW}_a	CLK	\overline{WE}	\overline{OE}	A	A	NC
C	DQP _c	NC	V _{DDQ}	V _{SS}	V _{SS}	V _{SS}	V _{SS}	V _{SS}	V _{DDQ}	NC	DQP _b
D	DQ _c	DQ _c	V _{DDQ}	V _{DD}	V _{SS}	V _{SS}	V _{SS}	V _{DD}	V _{DDQ}	DQ _b	DQ _b
E	DQ _c	DQ _c	V _{DDQ}	V _{DD}	V _{SS}	V _{SS}	V _{SS}	V _{DD}	V _{DDQ}	DQ _b	DQ _b
F	DQ _c	DQ _c	V _{DDQ}	V _{DD}	V _{SS}	V _{SS}	V _{SS}	V _{DD}	V _{DDQ}	DQ _b	DQ _b
G	DQ _c	DQ _c	V _{DDQ}	V _{DD}	V _{SS}	V _{SS}	V _{SS}	V _{DD}	V _{DDQ}	DQ _b	DQ _b
H	NC	NC	NC	V _{DD}	V _{SS}	V _{SS}	V _{SS}	V _{DD}	NC	NC	ZZ
J	DQ _d	DQ _d	V _{DDQ}	V _{DD}	V _{SS}	V _{SS}	V _{SS}	V _{DD}	V _{DDQ}	DQ _a	DQ _a
K	DQ _d	DQ _d	V _{DDQ}	V _{DD}	V _{SS}	V _{SS}	V _{SS}	V _{DD}	V _{DDQ}	DQ _a	DQ _a
L	DQ _d	DQ _d	V _{DDQ}	V _{DD}	V _{SS}	V _{SS}	V _{SS}	V _{DD}	V _{DDQ}	DQ _a	DQ _a
M	DQ _d	DQ _d	V _{DDQ}	V _{DD}	V _{SS}	V _{SS}	V _{SS}	V _{DD}	V _{DDQ}	DQ _a	DQ _a
N	DQP _d	NC	V _{DDQ}	V _{SS}	NC	NC	NC	V _{SS}	V _{DDQ}	NC	DQP _a
P	NC/144M	A	A	A	TDI	A1	TDO	A	A	A	NC/288M
R	MODE	A	A	A	TMS	A0	TCK	A	A	A	A

Note

2. Errata: The ZZ ball (H11) needs to be externally connected to ground. For more information, see Errata on page 35.

Pin Configurations (continued)

Figure 3. 209-ball FBGA (14 × 22 × 1.76 mm) pinout ^[3]
CY7C1474V33 (1M × 72)

	1	2	3	4	5	6	7	8	9	10	11
A	DQg	DQg	A	CE ₂	A	ADV/LD	A	CE ₃	A	DQb	DQb
B	DQg	DQg	BWS _c	BWS _g	NC	WE	A	BWS _b	BWS _f	DQb	DQb
C	DQg	DQg	BWS _h	BWS _d	NC/576M	CE ₁	NC	BWS _e	BWS _a	DQb	DQb
D	DQg	DQg	V _{SS}	NC	NC/1G	OE	NC	NC	V _{SS}	DQb	DQb
E	DQPg	DQPc	V _{DDQ}	V _{DDQ}	V _{DD}	V _{DD}	V _{DD}	V _{DDQ}	V _{DDQ}	DQPf	DQPb
F	DQc	DQc	V _{SS}	V _{SS}	V _{SS}	NC	V _{SS}	V _{SS}	V _{SS}	DQf	DQf
G	DQc	DQc	V _{DDQ}	V _{DDQ}	V _{DD}	NC	V _{DD}	V _{DDQ}	V _{DDQ}	DQf	DQf
H	DQc	DQc	V _{SS}	V _{SS}	V _{SS}	NC	V _{SS}	V _{SS}	V _{SS}	DQf	DQf
J	DQc	DQc	V _{DDQ}	V _{DDQ}	V _{DD}	NC	V _{DD}	V _{DDQ}	V _{DDQ}	DQf	DQf
K	NC	NC	CLK	NC	V _{SS}	CEN	V _{SS}	NC	NC	NC	NC
L	DQh	DQh	V _{DDQ}	V _{DDQ}	V _{DD}	NC	V _{DD}	V _{DDQ}	V _{DDQ}	DQa	DQa
M	DQh	DQh	V _{SS}	V _{SS}	V _{SS}	NC	V _{SS}	V _{SS}	V _{SS}	DQa	DQa
N	DQh	DQh	V _{DDQ}	V _{DDQ}	V _{DD}	NC	V _{DD}	V _{DDQ}	V _{DDQ}	DQa	DQa
P	DQh	DQh	V _{SS}	V _{SS}	V _{SS}	ZZ	V _{SS}	V _{SS}	V _{SS}	DQa	DQa
R	DQPd	DQPh	V _{DDQ}	V _{DDQ}	V _{DD}	V _{DD}	V _{DD}	V _{DDQ}	V _{DDQ}	DQPa	DQPe
T	DQd	DQd	V _{SS}	NC	NC	MODE	NC	NC	V _{SS}	DQe	DQe
U	DQd	DQd	NC/144M	A	A	A	A	A	NC/288M	DQe	DQe
V	DQd	DQd	A	A	A	A1	A	A	A	DQe	DQe
W	DQd	DQd	TMS	TDI	A	A0	A	TDO	TCK	DQe	DQe

Note

3. Errata: The ZZ ball (P6) needs to be externally connected to ground. For more information, see Errata on page 35.

Pin Definitions

Pin Name	I/O Type	Pin Description
A ₀ , A ₁ , A	Input-synchronous	Address inputs used to select one of the address locations. Sampled at the rising edge of the CLK.
\overline{BW}_a , \overline{BW}_b , \overline{BW}_c , \overline{BW}_d , \overline{BW}_e , \overline{BW}_f , \overline{BW}_g , \overline{BW}_h	Input-synchronous	Byte write select inputs, active LOW. Qualified with \overline{WE} to conduct writes to the SRAM. Sampled on the rising edge of CLK. \overline{BW}_a controls DQ _a and DQP _a , \overline{BW}_b controls DQ _b and DQP _b , \overline{BW}_c controls DQ _c and DQP _c , \overline{BW}_d controls DQ _d and DQP _d , \overline{BW}_e controls DQ _e and DQP _e , \overline{BW}_f controls DQ _f and DQP _f , \overline{BW}_g controls DQ _g and DQP _g , \overline{BW}_h controls DQ _h and DQP _h .
\overline{WE}	Input-synchronous	Write enable input, active LOW. Sampled on the rising edge of CLK if \overline{CEN} is active LOW. This signal must be asserted LOW to initiate a write sequence.
ADV/LD	Input-synchronous	Advance/load input used to advance the on-chip address counter or load a new address. When HIGH (and CEN is asserted LOW) the internal burst counter is advanced. When LOW, a new address can be loaded into the device for an access. After being deselected, ADV/LD should be driven LOW in order to load a new address.
CLK	Input-clock	Clock input. Used to capture all synchronous inputs to the device. CLK is qualified with \overline{CEN} . CLK is only recognized if CEN is active LOW.
\overline{CE}_1	Input-synchronous	Chip enable 1 input, active LOW. Sampled on the rising edge of CLK. Used in conjunction with \overline{CE}_2 and \overline{CE}_3 to select/deselect the device.
\overline{CE}_2	Input-synchronous	Chip enable 2 input, active HIGH. Sampled on the rising edge of CLK. Used in conjunction with \overline{CE}_1 and \overline{CE}_3 to select/deselect the device.
\overline{CE}_3	Input-synchronous	Chip enable 3 input, active LOW. Sampled on the rising edge of CLK. Used in conjunction with \overline{CE}_1 and \overline{CE}_2 to select/deselect the device.
\overline{OE}	Input-asynchronous	Output enable, active LOW. Combined with the synchronous logic block inside the device to control the direction of the I/O pins. When LOW, the I/O pins are allowed to behave as outputs. When deasserted HIGH, I/O pins are tristated, and act as input data pins. \overline{OE} is masked during the data portion of a write sequence, during the first clock when emerging from a deselected state and when the device has been deselected.
\overline{CEN}	Input-synchronous	Clock enable input, active LOW. When asserted LOW the clock signal is recognized by the SRAM. When deasserted HIGH the clock signal is masked. Since deasserting \overline{CEN} does not deselect the device, \overline{CEN} can be used to extend the previous cycle when required.
DQ _s	I/O-synchronous	Bidirectional data I/O lines. As inputs, they feed into an on-chip data register that is triggered by the rising edge of CLK. As outputs, they deliver the data contained in the memory location specified by A _[17:0] during the previous clock rise of the read cycle. The direction of the pins is controlled by \overline{OE} and the internal control logic. When \overline{OE} is asserted LOW, the pins can behave as outputs. When HIGH, DQ _a –DQ _d are placed in a tristate condition. The outputs are automatically tristated during the data portion of a write sequence, during the first clock when emerging from a deselected state, and when the device is deselected, regardless of the state of \overline{OE} .
DQP _x	I/O-synchronous	Bidirectional data parity I/O lines. Functionally, these signals are identical to DQ _x . During write sequences, DQP _a is controlled by \overline{BW}_a , DQP _b is controlled by \overline{BW}_b , DQP _c is controlled by \overline{BW}_c , and DQP _d is controlled by \overline{BW}_d , DQP _e is controlled by \overline{BW}_e , DQP _f is controlled by \overline{BW}_f , DQP _g is controlled by \overline{BW}_g , DQP _h is controlled by \overline{BW}_h .
MODE	Input strap pin	Mode input. Selects the burst order of the device. Tied HIGH selects the interleaved burst order. Pulled LOW selects the linear burst order. MODE should not change states during operation. When left floating MODE will default HIGH, to an interleaved burst order.
TDO	JTAG serial output synchronous	Serial data-out to the JTAG circuit. Delivers data on the negative edge of TCK.
TDI	JTAG serial input Synchronous	Serial data-in to the JTAG circuit. Sampled on the rising edge of TCK.

Pin Definitions *(continued)*

Pin Name	I/O Type	Pin Description
TMS	Test mode select synchronous	This pin controls the test access port state machine. Sampled on the rising edge of TCK.
TCK	JTAG clock	Clock input to the JTAG circuitry.
V _{DD}	Power supply	Power supply inputs to the core of the device.
V _{DDQ}	I/O power supply	Power supply for the I/O circuitry.
V _{SS}	Ground	Ground for the device. Should be connected to ground of the system.
NC	–	No connects. This pin is not connected to the die.
NC (144M, 288M, 576M, 1G)	–	These pins are not connected. They will be used for expansion to the 144M, 288M, 576M, and 1G densities.
ZZ ^[4]	Input-asynchronous	ZZ “Sleep” input. This active HIGH input places the device in a non-time critical “sleep” condition with data integrity preserved. During normal operation, this pin has to be LOW or left floating. ZZ pin has an internal pull-down.

Note

4. **Errata:** The ZZ pin needs to be externally connected to ground. For more information, see [Errata on page 35](#).

Functional Overview

The CY7C1470V33, CY7C1472V33, and CY7C1474V33 are synchronous-pipelined burst NoBL SRAMs designed specifically to eliminate wait states during write/read transitions. All synchronous inputs pass through input registers controlled by the rising edge of the clock. The clock signal is qualified with the clock enable input signal (CEN). If CEN is HIGH, the clock signal is not recognized and all internal states are maintained. All synchronous operations are qualified with CEN. All data outputs pass through output registers controlled by the rising edge of the clock. Maximum access delay from the clock rise (t_{CO}) is 3.0 ns (200 MHz device).

Accesses can be initiated by asserting all three chip enables (\overline{CE}_1 , \overline{CE}_2 , \overline{CE}_3) active at the rising edge of the clock. If clock enable (CEN) is active LOW and ADV/LD is asserted LOW, the address presented to the device will be latched. The access can either be a read or write operation, depending on the status of the write enable (\overline{WE}). $BW_{[x]}$ can be used to conduct byte write operations.

Write operations are qualified by the write enable (\overline{WE}). All writes are simplified with on-chip synchronous self timed write circuitry.

Three synchronous chip enables (\overline{CE}_1 , \overline{CE}_2 , \overline{CE}_3) and an asynchronous output enable (\overline{OE}) simplify depth expansion. All operations (reads, writes, and deselections) are pipelined. ADV/LD should be driven LOW after the device has been deselected in order to load a new address for the next operation.

Single Read Accesses

A read access is initiated when the following conditions are satisfied at clock rise: (1) CEN is asserted LOW, (2) \overline{CE}_1 , \overline{CE}_2 , and \overline{CE}_3 are all asserted active, (3) the write enable input signal \overline{WE} is deasserted HIGH, and (4) ADV/LD is asserted LOW. The address presented to the address inputs is latched into the address register and presented to the memory core and control logic. The control logic determines that a read access is in progress and allows the requested data to propagate to the input of the output register. At the rising edge of the next clock the requested data is allowed to propagate through the output register and onto the data bus within 3.0 ns (200 MHz device) provided OE is active LOW. After the first clock of the read access the output buffers are controlled by \overline{OE} and the internal control logic. \overline{OE} must be driven LOW in order for the device to drive out the requested data. During the second clock, a subsequent operation (read/write/deselect) can be initiated. Deselecting the device is also pipelined. Therefore, when the SRAM is deselected at clock rise by one of the chip enable signals, its output will tristate following the next clock rise.

Burst Read Accesses

The CY7C1470V33, CY7C1472V33, and CY7C1474V33 have an on-chip burst counter that allows the user the ability to supply a single address and conduct up to four reads without reasserting the address inputs. ADV/LD must be driven LOW in order to load a new address into the SRAM, as described in the [Single Read Accesses](#) section above. The sequence of the burst

counter is determined by the MODE input signal. A LOW input on MODE selects a linear burst mode, a HIGH selects an interleaved burst sequence. Both burst counters use A0 and A1 in the burst sequence, and will wrap-around when incremented sufficiently. A HIGH input on ADV/LD will increment the internal burst counter regardless of the state of chip enables inputs or \overline{WE} . \overline{WE} is latched at the beginning of a burst cycle. Therefore, the type of access (read or write) is maintained throughout the burst sequence.

Single Write Accesses

Write accesses are initiated when the following conditions are satisfied at clock rise: (1) CEN is asserted LOW, (2) \overline{CE}_1 , \overline{CE}_2 , and \overline{CE}_3 are all asserted active, and (3) the write signal \overline{WE} is asserted LOW. The address presented to the address inputs is loaded into the address register. The write signals are latched into the control logic block.

On the subsequent clock rise the data lines are automatically tristated regardless of the state of the OE input signal. This allows the external logic to present the data on DQ and DQP ($DQ_{a,b,c,d,e,f,g,h}/DQP_{a,b,c,d,e,f,g,h}$ for CY7C1474V33, $DQ_{a,b,c,d}/DQP_{a,b,c,d}$ for CY7C1470V33 and $DQ_{a,b}/DQP_{a,b}$ for CY7C1472V33). In addition, the address for the subsequent access (read/write/deselect) is latched into the address register (provided the appropriate control signals are asserted).

On the next clock rise the data presented to DQ and DQP ($DQ_{a,b,c,d,e,f,g,h}/DQP_{a,b,c,d,e,f,g,h}$ for CY7C1474V33, $DQ_{a,b,c,d}/DQP_{a,b,c,d}$ for CY7C1470V33 and $DQ_{a,b}/DQP_{a,b}$ for CY7C1472V33) (or a subset for byte write operations, see Write Cycle Description table for details) inputs is latched into the device and the write is complete.

The data written during the write operation is controlled by \overline{BW} ($BW_{a,b,c,d,e,f,g,h}$ for CY7C1474V33, $BW_{a,b,c,d}$ for CY7C1470V33 and $BW_{a,b}$ for CY7C1472V33) signals. The CY7C1470V33, CY7C1472V33, and CY7C1474V33 provides byte write capability that is described in the Write Cycle Description table. Asserting the write enable input (\overline{WE}) with the selected byte write select (\overline{BW}) input will selectively write to only the desired bytes. Bytes not selected during a byte write operation will remain unaltered. A synchronous self timed Write mechanism has been provided to simplify the write operations. Byte write capability has been included in order to greatly simplify read/modify/write sequences, which can be reduced to simple byte write operations.

Because the CY7C1470V33, CY7C1472V33, and CY7C1474V33 are common I/O devices, data should not be driven into the device while the outputs are active. The output enable (\overline{OE}) can be deasserted HIGH before presenting data to the DQ and DQP ($DQ_{a,b,c,d,e,f,g,h}/DQP_{a,b,c,d,e,f,g,h}$ for CY7C1474V33, $DQ_{a,b,c,d}/DQP_{a,b,c,d}$ for CY7C1470V33 and $DQ_{a,b}/DQP_{a,b}$ for CY7C1472V33) inputs. Doing so will tristate the output drivers. As a safety precaution, DQ and DQP ($DQ_{a,b,c,d,e,f,g,h}/DQP_{a,b,c,d,e,f,g,h}$ for CY7C1474V33, $DQ_{a,b,c,d}/DQP_{a,b,c,d}$ for CY7C1470V33 and $DQ_{a,b}/DQP_{a,b}$ for CY7C1472V33) are automatically tristated during the data portion of a write cycle, regardless of the state of \overline{OE} .

Burst Write Accesses

The CY7C1470V33, CY7C1472V33, and CY7C1474V33 has an on-chip burst counter that allows the user the ability to supply a single address and conduct up to four write operations without reasserting the address inputs. ADV/LD must be driven LOW in order to load the initial address, as described in the [Single Write Accesses](#) section above. When ADV/LD is driven HIGH on the subsequent clock rise, the chip enables (\overline{CE}_1 , \overline{CE}_2 , and \overline{CE}_3) and WE inputs are ignored and the burst counter is incremented. The correct BW ($BW_{a,b,c,d,e,f,g,h}$ for CY7C1474V33, $BW_{a,b,c,d}$ for CY7C1470V33 and $BW_{a,b}$ for CY7C1472V33) inputs must be driven in each cycle of the burst write in order to write the correct bytes of data.

Sleep Mode

The ZZ input pin is an asynchronous input. Asserting ZZ places the SRAM in a power conservation “sleep” mode. Two clock cycles are required to enter into or exit from this “sleep” mode. While in this mode, data integrity is guaranteed. Accesses pending when entering the “sleep” mode are not considered valid nor is the completion of the operation guaranteed. The device must be deselected prior to entering the “sleep” mode. \overline{CE}_1 , \overline{CE}_2 , and \overline{CE}_3 , must remain inactive for the duration of t_{ZZREC} after the ZZ input returns LOW.

Interleaved Burst Address Table

(MODE = Floating or V_{DD})

First Address A1:A0	Second Address A1:A0	Third Address A1:A0	Fourth Address A1:A0
00	01	10	11
01	00	11	10
10	11	00	01
11	10	01	00

Linear Burst Address Table

(MODE = GND)

First Address A1:A0	Second Address A1:A0	Third Address A1:A0	Fourth Address A1:A0
00	01	10	11
01	10	11	00
10	11	00	01
11	00	01	10

ZZ Mode Electrical Characteristics

Parameter	Description	Test Conditions	Min	Max	Unit
I_{DDZZ}	Sleep mode standby current	$ZZ \geq V_{DD} - 0.2 V$	–	120	mA
t_{ZZS}	Device operation to ZZ	$ZZ \geq V_{DD} - 0.2 V$	–	$2t_{CYC}$	ns
t_{ZZREC}	ZZ recovery time	$ZZ \leq 0.2 V$	$2t_{CYC}$	–	ns
t_{ZZI}	ZZ active to sleep current	This parameter is sampled	–	$2t_{CYC}$	ns
t_{RZZI}	ZZ Inactive to exit sleep current	This parameter is sampled	0	–	ns

Truth Table

The Truth Table for parts CY7C1470V33/CY7C1472V33/CY7C1474V33 is as follows. [5, 6, 7, 8, 9, 10, 11]

Operation	Address Used	\overline{CE}	ZZ	$\overline{ADV/LD}$	\overline{WE}	\overline{BW}_x	\overline{OE}	\overline{CEN}	CLK	DQ
Deselect cycle	None	H	L	L	X	X	X	L	L-H	Tri-state
Continue deselect cycle	None	X	L	H	X	X	X	L	L-H	Tri-state
Read cycle (begin burst)	External	L	L	L	H	X	L	L	L-H	Data out (Q)
Read cycle (continue burst)	Next	X	L	H	X	X	L	L	L-H	Data out (Q)
NOP/dummy read (begin burst)	External	L	L	L	H	X	H	L	L-H	Tri-state
Dummy read (continue burst)	Next	X	L	H	X	X	H	L	L-H	Tri-state
Write cycle (begin burst)	External	L	L	L	L	L	X	L	L-H	Data in (D)
Write cycle (continue burst)	Next	X	L	H	X	L	X	L	L-H	Data in (D)
NOP/write abort (begin burst)	None	L	L	L	L	H	X	L	L-H	Tri-state
Write abort (continue burst)	Next	X	L	H	X	H	X	L	L-H	Tri-state
Ignore clock edge (stall)	Current	X	L	X	X	X	X	H	L-H	-
Sleep mode	None	X	H	X	X	X	X	X	X	Tri-state

Notes

5. X = "Don't Care", H = Logic HIGH, L = Logic LOW, \overline{CE} stands for all chip enables active. $\overline{BW}_x = 0$ signifies at least one byte write select is active, $\overline{BW}_x = \text{valid}$ signifies that the desired byte write selects are asserted, see Write Cycle Description table for details.
6. Write is defined by \overline{WE} and $\overline{BW}_{[a:d]}$. See Write Cycle Description table for details.
7. When a write cycle is detected, all I/Os are tristated, even during byte writes.
8. The DQ and DQP pins are controlled by the current cycle and the \overline{OE} signal.
9. $\overline{CEN} = H$ inserts wait states.
10. Device will power-up deselected and the I/Os in a tristate condition, regardless of \overline{OE} .
11. \overline{OE} is asynchronous and is not sampled with the clock rise. It is masked internally during Write cycles. During a Read cycle DQ_s and $DQP_{[a:d]}$ = tristate when \overline{OE} is inactive or when the device is deselected, and $DQ_s = \text{data}$ when \overline{OE} is active.

Partial Write Cycle Description

The partial write cycle description for part CY7C1470V33 is as follows. [12, 13, 14, 15]

Function (CY7C1470V33)	\overline{WE}	\overline{BW}_d	\overline{BW}_c	\overline{BW}_b	\overline{BW}_a
Read	H	X	X	X	X
Write – no bytes written	L	H	H	H	H
Write byte a – (DQ _a and DQP _a)	L	H	H	H	L
Write byte b – (DQ _b and DQP _b)	L	H	H	L	H
Write bytes b, a	L	H	H	L	L
Write byte c – (DQ _c and DQP _c)	L	H	L	H	H
Write bytes c, a	L	H	L	H	L
Write bytes c, b	L	H	L	L	H
Write bytes c, b, a	L	H	L	L	L
Write byte d – (DQ _d and DQP _d)	L	L	H	H	H
Write bytes d, a	L	L	H	H	L
Write bytes d, b	L	L	H	L	H
Write bytes d, b, a	L	L	H	L	L
Write bytes d, c	L	L	L	H	H
Write bytes d, c, a	L	L	L	H	L
Write bytes d, c, b	L	L	L	L	H
Write all bytes	L	L	L	L	L

Partial Write Cycle Description

The partial write cycle description for part CY7C1472V33 is as follows. [12, 13, 14, 15]

Function (CY7C1472V33)	\overline{WE}	\overline{BW}_b	\overline{BW}_a
Read	H	x	x
Write – no bytes written	L	H	H
Write byte a – (DQ _a and DQP _a)	L	H	L
Write byte b – (DQ _b and DQP _b)	L	L	H
Write both bytes	L	L	L

Notes

12. X = "Don't Care", H = Logic HIGH, L = Logic LOW, \overline{CE} stands for all chip enables active. $\overline{BW}x = 0$ signifies at least one byte write select is active, $\overline{BW}x = \text{valid}$ signifies that the desired byte write selects are asserted, see Write Cycle Description table for details.
13. Write is defined by \overline{WE} and $\overline{BW}_{[a:d]}$. See Write Cycle Description table for details.
14. When a write cycle is detected, all I/Os are tristated, even during byte writes.
15. Table only lists a partial listing of the Byte Write combinations. Any combination of $\overline{BW}_{[a:d]}$ is valid. Appropriate write will be done based on which Byte Write is active.

Partial Write Cycle Description

The partial write cycle description for part CY7C1474V33 is as follows. [16, 17, 18, 19]

Function (CY7C1474V33)	\overline{WE}	\overline{BW}_x
Read	H	x
Write – no bytes written	L	H
Write byte X – (DQ _x and DQP _x)	L	L
Write all bytes	L	All $\overline{BW} = L$

Notes

16. X = "Don't Care", H = Logic HIGH, L = Logic LOW, \overline{CE} stands for all chip enables active. $\overline{BW}_x = 0$ signifies at least one byte write select is active, $\overline{BW}_x = \text{valid}$ signifies that the desired byte write selects are asserted, see Write Cycle Description table for details.
17. Write is defined by \overline{WE} and $\overline{BW}_{[a:d]}$. See Write Cycle Description table for details.
18. When a write cycle is detected, all I/Os are tristated, even during byte writes.
19. Table only lists a partial listing of the Byte Write combinations. Any combination of $\overline{BW}_{[a:d]}$ is valid. Appropriate write will be done based on which Byte Write is active.

IEEE 1149.1 Serial Boundary Scan (JTAG)

The CY7C1470V33, and CY7C1474V33 incorporates a serial boundary scan test access port (TAP). This port operates in accordance with IEEE Standard 1149.1-1990 but does not have the set of functions required for full 1149.1 compliance. These functions from the IEEE specification are excluded because their inclusion places an added delay in the critical speed path of the SRAM. Note that the TAP controller functions in a manner that does not conflict with the operation of other devices using 1149.1 fully compliant TAPs. The TAP operates using JEDEC-standard 3.3 V or 2.5 V I/O logic levels.

The CY7C1470V33, and CY7C1474V33 contains a TAP controller, instruction register, boundary scan register, bypass register, and ID register.

Disabling the JTAG Feature

It is possible to operate the SRAM without using the JTAG feature. To disable the TAP controller, TCK must be tied LOW (V_{SS}) to prevent clocking of the device. TDI and TMS are internally pulled up and may be unconnected. They may alternately be connected to V_{DD} through a pull up resistor. TDO should be left unconnected. Upon power-up, the device will come up in a reset state which will not interfere with the operation of the device.

Test Access Port (TAP)

Test Clock (TCK)

The test clock is used only with the TAP controller. All inputs are captured on the rising edge of TCK. All outputs are driven from the falling edge of TCK.

Test Mode Select (TMS)

The TMS input is used to give commands to the TAP controller and is sampled on the rising edge of TCK. It is allowable to leave this ball unconnected if the TAP is not used. The ball is pulled up internally, resulting in a logic HIGH level.

Test Data-In (TDI)

The TDI ball is used to serially input information into the registers and can be connected to the input of any of the registers. The register between TDI and TDO is chosen by the instruction that is loaded into the TAP instruction register. For information on loading the instruction register, see the [TAP Controller State Diagram on page 17](#). TDI is internally pulled up and can be unconnected if the TAP is unused in an application. TDI is connected to the most significant bit (MSB) of any register.

Test Data-Out (TDO)

The TDO output ball is used to serially clock data-out from the registers. The output is active depending upon the current state of the TAP state machine (see [Identification Codes on page 21](#)). The output changes on the falling edge of TCK. TDO is connected to the least significant bit (LSB) of any register.

Performing a TAP Reset

A RESET is performed by forcing TMS HIGH (V_{DD}) for five rising edges of TCK. This RESET does not affect the operation of the SRAM and may be performed while the SRAM is operating.

At power-up, the TAP is reset internally to ensure that TDO comes up in a high Z state.

TAP Registers

Registers are connected between the TDI and TDO balls and allow data to be scanned into and out of the SRAM test circuitry. Only one register can be selected at a time through the instruction register. Data is serially loaded into the TDI ball on the rising edge of TCK. Data is output on the TDO ball on the falling edge of TCK.

Instruction Register

Three bit instructions can be serially loaded into the instruction register. This register is loaded when it is placed between the TDI and TDO balls as shown in the [TAP Controller Block Diagram on page 18](#). Upon power-up, the instruction register is loaded with the IDCODE instruction. It is also loaded with the IDCODE instruction if the controller is placed in a reset state as described in the previous section.

When the TAP controller is in the Capture-IR state, the two least significant bits are loaded with a binary "01" pattern to allow for fault isolation of the board-level serial test data path.

Bypass Register

To save time when serially shifting data through registers, it is sometimes advantageous to skip certain chips. The bypass register is a single bit register that can be placed between the TDI and TDO balls. This allows data to be shifted through the SRAM with minimal delay. The bypass register is set LOW (V_{SS}) when the BYPASS instruction is executed.

Boundary Scan Register

The boundary scan register is connected to all the input and bidirectional balls on the SRAM.

The boundary scan register is loaded with the contents of the RAM I/O ring when the TAP controller is in the Capture-DR state and is then placed between the TDI and TDO balls when the controller is moved to the Shift-DR state. The EXTEST, SAMPLE/PRELOAD and SAMPLE Z instructions can be used to capture the contents of the I/O ring.

The [Boundary Scan Exit Order on page 22](#) and [Boundary Scan Exit Order on page 23](#) show the order in which the bits are connected. Each bit corresponds to one of the bumps on the SRAM package. The MSB of the register is connected to TDI and the LSB is connected to TDO.

Identification (ID) Register

The ID register is loaded with a vendor-specific, 32-bit code during the Capture-DR state when the IDCODE command is loaded in the instruction register. The IDCODE is hardwired into the SRAM and can be shifted out when the TAP controller is in the Shift-DR state. The ID register has a vendor code and other information described in the Identification Register Definitions table.

TAP Instruction Set

Overview

Eight different instructions are possible with the three bit instruction register. All combinations are listed in [Identification](#)

Codes on page 21. Three of these instructions are listed as RESERVED and should not be used. The other five instructions are described in detail below.

The TAP controller used in this SRAM is not fully compliant to the 1149.1 convention because some of the mandatory 1149.1 instructions are not fully implemented.

The TAP controller cannot be used to load address data or control signals into the SRAM and cannot preload the I/O buffers. The SRAM does not implement the 1149.1 commands EXTEST or INTEST or the PRELOAD portion of SAMPLE/PRELOAD; rather, it performs a capture of the I/O ring when these instructions are executed.

Instructions are loaded into the TAP controller during the Shift-IR state when the instruction register is placed between TDI and TDO. During this state, instructions are shifted through the instruction register through the TDI and TDO balls. To execute the instruction after it is shifted in, the TAP controller needs to be moved into the Update-IR state.

EXTEST

EXTEST is a mandatory 1149.1 instruction which is to be executed whenever the instruction register is loaded with all 0s. EXTEST is not implemented in this SRAM TAP controller, and therefore this device is not compliant to 1149.1. The TAP controller does not recognize an all-0 instruction.

When an EXTEST instruction is loaded into the instruction register, the SRAM responds as if a SAMPLE/PRELOAD instruction has been loaded. There is one difference between the two instructions. Unlike the SAMPLE/PRELOAD instruction, EXTEST places the SRAM outputs in a high Z state.

IDCODE

The IDCODE instruction causes a vendor-specific, 32-bit code to be loaded into the instruction register. It also places the instruction register between the TDI and TDO balls and allows the IDCODE to be shifted out of the device when the TAP controller enters the Shift-DR state.

The IDCODE instruction is loaded into the instruction register upon power up or whenever the TAP controller is given a test logic reset state.

SAMPLE Z

The SAMPLE Z instruction causes the boundary scan register to be connected between the TDI and TDO balls when the TAP controller is in a Shift-DR state. It also places all SRAM outputs into a high Z state.

SAMPLE/PRELOAD

SAMPLE/PRELOAD is a 1149.1 mandatory instruction. The PRELOAD portion of this instruction is not implemented, so the device TAP controller is not fully 1149.1 compliant.

When the SAMPLE/PRELOAD instruction is loaded into the instruction register and the TAP controller is in the Capture-DR state, a snapshot of data on the inputs and bidirectional balls is captured in the boundary scan register.

The user must be aware that the TAP controller clock can only operate at a frequency up to 20 MHz, while the SRAM clock operates more than an order of magnitude faster. Because there is a large difference in the clock frequencies, it is possible that during the Capture-DR state, an input or output will undergo a transition. The TAP may then try to capture a signal while in transition (metastable state). This will not harm the device, but there is no guarantee as to the value that will be captured. Repeatable results may not be possible.

To guarantee that the boundary scan register will capture the correct value of a signal, the SRAM signal must be stabilized long enough to meet the TAP controller's capture setup plus hold time (t_{CS} plus t_{CH}).

The SRAM clock input might not be captured correctly if there is no way in a design to stop (or slow) the clock during a SAMPLE/PRELOAD instruction. If this is an issue, it is still possible to capture all other signals and simply ignore the value of the CLK captured in the boundary scan register.

After the data is captured, it is possible to shift out the data by putting the TAP into the Shift-DR state. This places the boundary scan register between the TDI and TDO balls.

Note that since the PRELOAD part of the command is not implemented, putting the TAP to the Update-DR state while performing a SAMPLE/PRELOAD instruction will have the same effect as the Pause-DR command.

BYPASS

When the BYPASS instruction is loaded in the instruction register and the TAP is placed in a Shift-DR state, the bypass register is placed between the TDI and TDO balls. The advantage of the BYPASS instruction is that it shortens the boundary scan path when multiple devices are connected together on a board.

Reserved

These instructions are not implemented but are reserved for future use. Do not use these instructions.

TAP Controller State Diagram

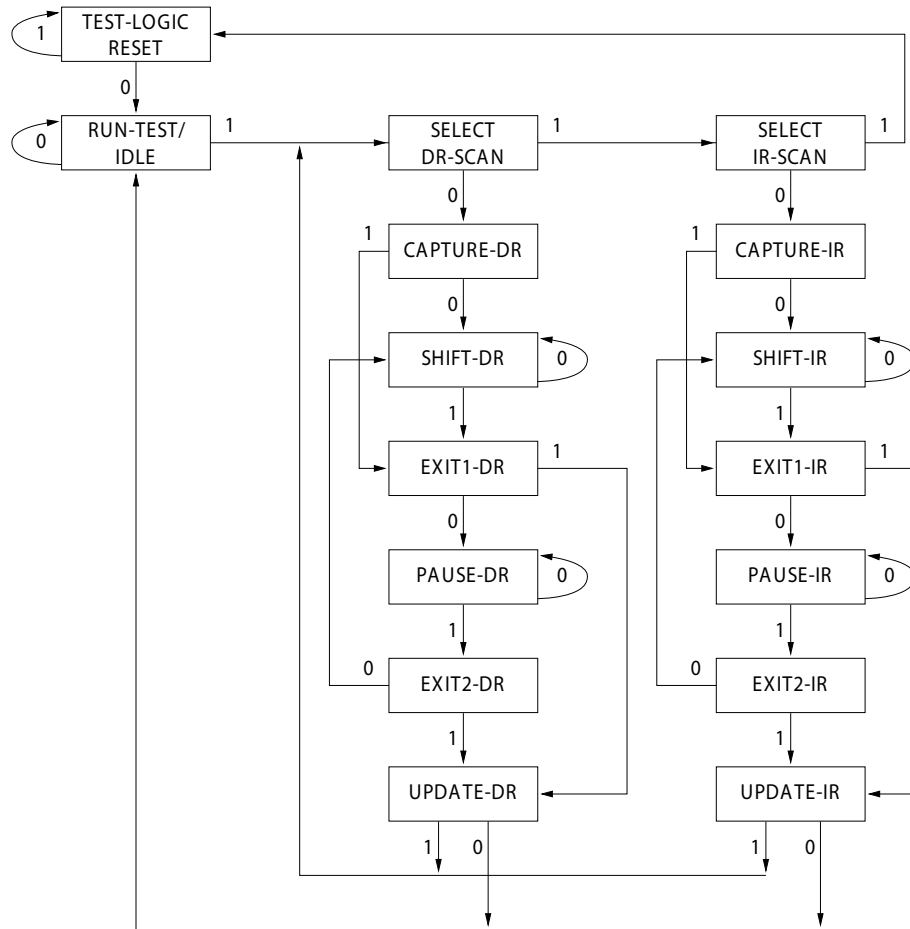

The 0/1 next to each state represents the value of TMS at the rising edge of TCK.

TAP Controller Block Diagram

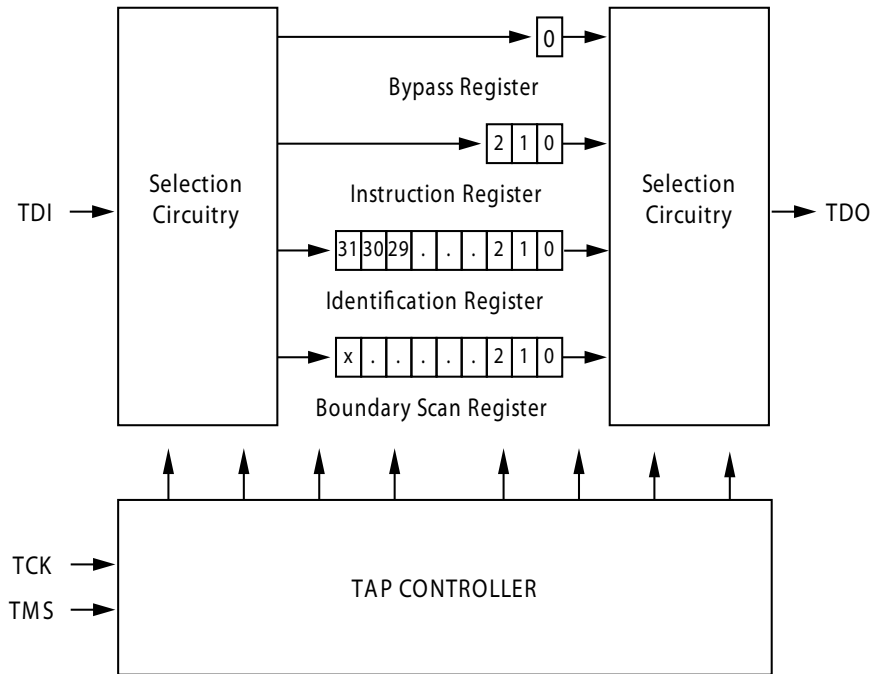

TAP Timing Diagram

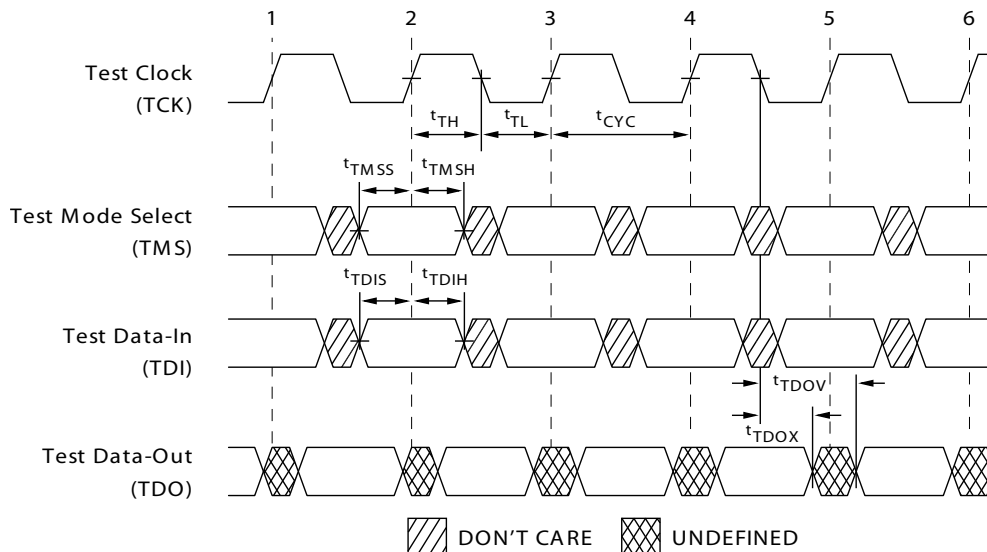

TAP AC Switching Characteristics

Over the Operating Range

Parameter ^[20, 21]	Description	Min	Max	Unit
Clock				
t_{TCYC}	TCK clock cycle time	50	–	ns
t_{TF}	TCK clock frequency	–	20	MHz
t_{TH}	TCK clock HIGH time	20	–	ns
t_{TL}	TCK clock LOW time	20	–	ns
Output Times				
t_{TDOV}	TCK clock LOW to TDO valid	–	10	ns
t_{TDOX}	TCK clock LOW to TDO invalid	0	–	ns
Setup Times				
t_{TMSS}	TMS setup to TCK clock rise	5	–	ns
t_{TDIS}	TDI setup to TCK clock rise	5	–	ns
t_{CS}	Capture setup to TCK rise	5	–	ns
Hold Times				
t_{TMSH}	TMS hold after TCK clock rise	5	–	ns
t_{TDIH}	TDI hold after clock rise	5	–	ns
t_{CH}	Capture hold after clock rise	5	–	ns

Notes

20. t_{CS} and t_{CH} refer to the setup and hold time requirements of latching data from the boundary scan register.
21. Test conditions are specified using the load in TAP AC Test Conditions. $t_R/t_F = 1$ ns.

3.3 V TAP AC Test Conditions

Input pulse levels V_{SS} to 3.3 V
 Input rise and fall times 1 ns
 Input timing reference levels 1.5 V
 Output reference levels 1.5 V
 Test load termination supply voltage 1.5 V

2.5 V TAP AC Test Conditions

Input pulse levels V_{SS} to 2.5 V
 Input rise and fall time 1 ns
 Input timing reference levels 1.25 V
 Output reference levels 1.25 V
 Test load termination supply voltage 1.25 V

3.3 V TAP AC Output Load Equivalent

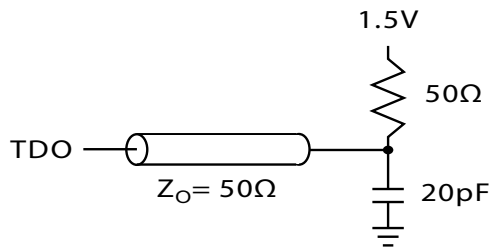

2.5 V TAP AC Output Load Equivalent

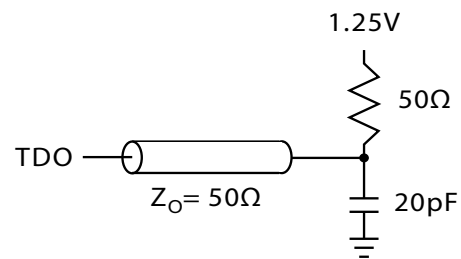

TAP DC Electrical Characteristics and Operating Conditions

(0 °C < T_A < +70 °C; V_{DD} = 3.135 V to 3.6 V unless otherwise noted)

Parameter ^[22]	Description	Test Conditions	Min	Max	Unit
V_{OH1}	Output HIGH voltage	$I_{OH} = -4.0$ mA, $V_{DDQ} = 3.3$ V	2.4	–	V
		$I_{OH} = -1.0$ mA, $V_{DDQ} = 2.5$ V	2.0	–	V
V_{OH2}	Output HIGH voltage	$I_{OH} = -100$ μ A, $V_{DDQ} = 3.3$ V	2.9	–	V
		$V_{DDQ} = 2.5$ V	2.1	–	V
V_{OL1}	Output LOW voltage	$I_{OL} = 8.0$ mA, $V_{DDQ} = 3.3$ V	–	0.4	V
		$I_{OL} = 1.0$ mA, $V_{DDQ} = 2.5$ V	–	0.4	V
V_{OL2}	Output LOW voltage	$I_{OL} = 100$ μ A, $V_{DDQ} = 3.3$ V	–	0.2	V
		$V_{DDQ} = 2.5$ V	–	0.2	V
V_{IH}	Input HIGH voltage	$V_{DDQ} = 3.3$ V	2.0	$V_{DD} + 0.3$	V
		$V_{DDQ} = 2.5$ V	1.7	$V_{DD} + 0.3$	V
V_{IL}	Input LOW voltage	$V_{DDQ} = 3.3$ V	–0.3	0.8	V
		$V_{DDQ} = 2.5$ V	–0.3	0.7	V
I_x	Input load current	$GND \leq V_{IN} \leq V_{DDQ}$	–5	5	μ A

Note

22. All voltages referenced to V_{SS} (GND).

Identification Register Definitions

Instruction Field	CY7C1470V33 (2M x 36)	CY7C1474V33 (1M x 72)	Description
Revision number (31:29)	000	000	Describes the version number
Device depth (28:24) ^[23]	01011	01011	Reserved for internal use
Architecture/memory type (23:18)	001000	001000	Defines memory type and architecture
Bus width/density (17:12)	100100	110100	Defines width and density
Cypress JEDEC ID code (11:1)	00000110100	00000110100	Allows unique identification of SRAM vendor
ID register presence indicator (0)	1	1	Indicates the presence of an ID register

Scan Register Sizes

Register Name	Bit Size (x 36)	Bit Size (x 72)
Instruction	3	3
Bypass	1	1
ID	32	32
Boundary scan order – 165-ball FBGA	71	–
Boundary scan order – 209-ball FBGA	–	110

Identification Codes

Instruction	Code	Description
EXTEST	000	Captures I/O ring contents. Places the boundary scan register between TDI and TDO. Forces all SRAM outputs to high Z state. This instruction is not 1149.1 compliant.
IDCODE	001	Loads the ID register with the vendor ID code and places the register between TDI and TDO. This operation does not affect SRAM operations.
SAMPLE Z	010	Captures I/O ring contents. Places the boundary scan register between TDI and TDO. Forces all SRAM output drivers to a high Z state.
RESERVED	011	Do Not Use: This instruction is reserved for future use.
SAMPLE/PRELOAD	100	Captures I/O ring contents. Places the boundary scan register between TDI and TDO. Does not affect SRAM operation. This instruction does not implement 1149.1 preload function and is therefore not 1149.1 compliant.
RESERVED	101	Do Not Use: This instruction is reserved for future use.

Note

23. Bit #24 is "1" in the ID Register Definitions for both 2.5 V and 3.3 V versions of this device.

Boundary Scan Exit Order

(2M x 36)

Bit #	165-ball ID
1	C1
2	D1
3	E1
4	D2
5	E2
6	F1
7	G1
8	F2
9	G2
10	J1
11	K1
12	L1
13	J2
14	M1
15	N1
16	K2
17	L2
18	M2
19	R1
20	R2

Bit #	165-ball ID
21	R3
22	P2
23	R4
24	P6
25	R6
26	R8
27	P3
28	P4
29	P8
30	P9
31	P10
32	R9
33	R10
34	R11
35	N11
36	M11
37	L11
38	M10
39	L10
40	K11

Bit #	165-ball ID
41	J11
42	K10
43	J10
44	H11
45	G11
46	F11
47	E11
48	D10
49	D11
50	C11
51	G10
52	F10
53	E10
54	A9
55	B9
56	A10
57	B10
58	A8
59	B8
60	A7

Bit #	165-ball ID
61	B7
62	B6
63	A6
64	B5
65	A5
66	A4
67	B4
68	B3
69	A3
70	A2
71	B2

Boundary Scan Exit Order

(1M x 72)

Bit #	209-ball ID
1	A1
2	A2
3	B1
4	B2
5	C1
6	C2
7	D1
8	D2
9	E1
10	E2
11	F1
12	F2
13	G1
14	G2
15	H1
16	H2
17	J1
18	J2
19	L1
20	L2
21	M1
22	M2
23	N1
24	N2
25	P1
26	P2
27	R2
28	R1

Bit #	209-ball ID
29	T1
30	T2
31	U1
32	U2
33	V1
34	V2
35	W1
36	W2
37	T6
38	V3
39	V4
40	U4
41	W5
42	V6
43	W6
44	V5
45	U5
46	U6
47	W7
48	V7
49	U7
50	V8
51	V9
52	W11
53	W10
54	V11
55	V10
56	U11

Bit #	209-ball ID
57	U10
58	T11
59	T10
60	R11
61	R10
62	P11
63	P10
64	N11
65	N10
66	M11
67	M10
68	L11
69	L10
70	P6
71	J11
72	J10
73	H11
74	H10
75	G11
76	G10
77	F11
78	F10
79	E10
80	E11
81	D11
82	D10
83	C11
84	C10

Bit #	209-ball ID
85	B11
86	B10
87	A11
88	A10
89	A7
90	A5
91	A9
92	U8
93	A6
94	D6
95	K6
96	B6
97	K3
98	A8
99	B4
100	B3
101	C3
102	C4
103	C8
104	C9
105	B9
106	B8
107	A4
108	C6
109	B7
110	A3

Maximum Ratings

Exceeding maximum ratings may shorten the useful life of the device. User guidelines are not tested.

Storage temperature -65 °C to +150 °C
 Ambient temperature
 with power applied -55 °C to +125 °C
 Supply voltage on V_{DD} relative to GND -0.5 V to +4.6 V
 Supply voltage on V_{DDQ} relative to GND -0.5 V to + V_{DD}
 DC to outputs in tri-state -0.5 V to $V_{DDQ} + 0.5$ V
 DC input voltage -0.5 V to $V_{DD} + 0.5$ V
 Current into outputs (LOW) 20 mA
 Static discharge voltage
 (per MIL-STD-883, method 3015) > 2001 V
 Latch-up current > 200 mA

Operating Range

Range	Ambient Temperature	V_{DD}	V_{DDQ}
Commercial	0 °C to +70 °C	3.3 V – 5% / + 10%	2.5 V – 5% to V_{DD}
Industrial	-40 °C to +85 °C		

Neutron Soft Error Immunity

Parameter	Description	Test Conditions	Typ	Max*	Unit
LSBU	Logical single bit upsets	25 °C	361	394	FIT/Mb
LMBU	Logical multi bit upsets	25 °C	0	0.01	FIT/Mb
SEL	Single event latch-up	85 °C	0	0.1	FIT/Dev

* No LMBU or SEL events occurred during testing; this column represents a statistical χ^2 , 95% confidence limit calculation. For more details refer to Application Note AN54908 "Accelerated Neutron SER Testing and Calculation of Terrestrial Failure Rates".

Electrical Characteristics

Over the Operating Range

Parameter ^[24, 25]	Description	Test Conditions	Min	Max	Unit	
V_{DD}	Power supply voltage		3.135	3.6	V	
V_{DDQ}	I/O supply voltage	for 3.3 V I/O	3.135	V_{DD}	V	
		for 2.5 V I/O	2.375	2.625	V	
V_{OH}	Output HIGH voltage	for 3.3 V I/O, $I_{OH} = -4.0$ mA	2.4	–	V	
		for 2.5 V I/O, $I_{OH} = -1.0$ mA	2.0	–	V	
V_{OL}	Output LOW voltage	for 3.3 V I/O, $I_{OL} = 8.0$ mA	–	0.4	V	
		for 2.5 V I/O, $I_{OL} = 1.0$ mA	–	0.4	V	
V_{IH}	Input HIGH voltage ^[24]	for 3.3 V I/O	2.0	$V_{DD} + 0.3$	V	
		for 2.5 V I/O	1.7	$V_{DD} + 0.3$	V	
V_{IL}	Input LOW voltage ^[24]	for 3.3 V I/O	-0.3	0.8	V	
		for 2.5 V I/O	-0.3	0.7	V	
I_X	Input leakage current except ZZ and MODE	$GND \leq V_I \leq V_{DDQ}$	-5	5	μ A	
		Input current of MODE	Input = V_{SS}	-30	–	μ A
			Input = V_{DD}	–	5	μ A
		Input current of ZZ	Input = V_{SS}	-5	–	μ A
Input = V_{DD}	–		30	μ A		
I_{OZ}	Output leakage current	$GND \leq V_I \leq V_{DDQ}$, output disabled	-5	5	μ A	

Notes

24. Overshoot: $V_{IH(AC)} < V_{DD} + 1.5$ V (Pulse width less than $t_{CYC/2}$), undershoot: $V_{IL(AC)} > -2$ V (Pulse width less than $t_{CYC/2}$).
 25. $T_{power\ up}$: Assumes a linear ramp from 0 V to $V_{DD(Min)}$ within 200 ms. During this time $V_{IH} < V_{DD}$ and $V_{DDQ} \leq V_{DD}$.

Electrical Characteristics *(continued)*

Over the Operating Range

Parameter ^[24, 25]	Description	Test Conditions		Min	Max	Unit
I _{DD}	V _{DD} operating supply	V _{DD} = Max, I _{OUT} = 0 mA, f = f _{MAX} = 1/t _{CYC}	5.0 ns cycle, 200 MHz	–	500	mA
			6.0 ns cycle, 167 MHz	–	450	mA
I _{SB1}	Automatic CE power-down current – TTL inputs	Max V _{DD} , device deselected, V _{IN} ≥ V _{IH} or V _{IN} ≤ V _{IL} , f = f _{MAX} = 1/t _{CYC}	5.0 ns cycle, 200 MHz	–	245	mA
			6.0 ns cycle, 167 MHz	–	245	mA
I _{SB2}	Automatic CE power-down current – CMOS inputs	Max V _{DD} , device deselected, V _{IN} ≤ 0.3 V or V _{IN} ≥ V _{DDQ} – 0.3 V, f = 0	All speed grades	–	120	mA
I _{SB3}	Automatic CE power-down current – CMOS inputs	Max V _{DD} , device deselected, V _{IN} ≤ 0.3 V or V _{IN} ≥ V _{DDQ} – 0.3 V, f = f _{MAX} = 1/t _{CYC}	5.0 ns cycle, 200 MHz	–	245	mA
			6.0 ns cycle, 167 MHz	–	245	mA
I _{SB4}	Automatic CE power-down current – TTL inputs	Max V _{DD} , device deselected, V _{IN} ≥ V _{IH} or V _{IN} ≤ V _{IL} , f = 0	All speed grades	–	135	mA

Capacitance

Parameter ^[26]	Description	Test Conditions	100-pin TQFP Max	165-ball FBGA Max	209-ball FBGA Max	Unit
C _{ADDRESS}	Address input capacitance	T _A = 25 °C, f = 1 MHz, V _{DD} = 3.3 V, V _{DDQ} = 2.5 V	6	6	6	pF
C _{DATA}	Data input capacitance		5	5	5	pF
C _{CTRL}	Control input capacitance		8	8	8	pF
C _{CLK}	Clock input capacitance		6	6	6	pF
C _{I/O}	Input/output capacitance		5	5	5	pF

Thermal Resistance

Parameter ^[26]	Description	Test Conditions	100-pin TQFP Package	165-ball FBGA Package	209-ball FBGA Package	Unit
Θ _{JA}	Thermal resistance (junction to ambient)	Test conditions follow standard test methods and procedures for measuring thermal impedance, per EIA/JESD51.	24.63	16.3	15.2	°C/W
Θ _{JC}	Thermal resistance (junction to case)		2.28	2.1	1.7	°C/W

Note

26. Tested initially and after any design or process changes that may affect these parameters.

AC Test Loads and Waveforms

Figure 4. AC Test Loads and Waveforms

3.3 V I/O Test Load

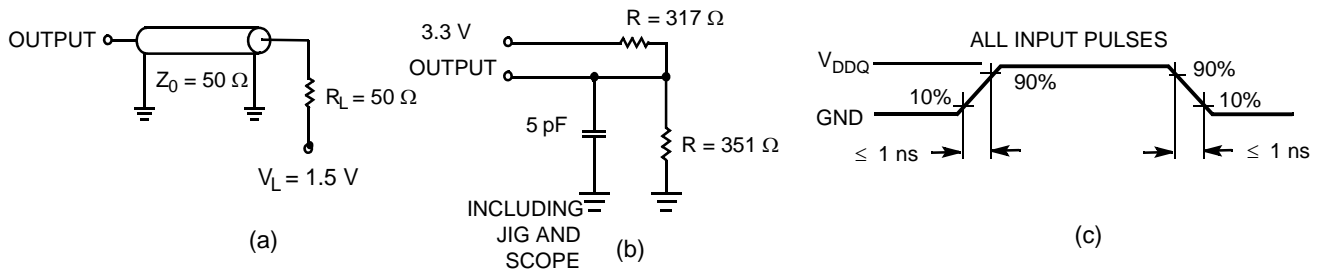

2.5 V I/O Test Load

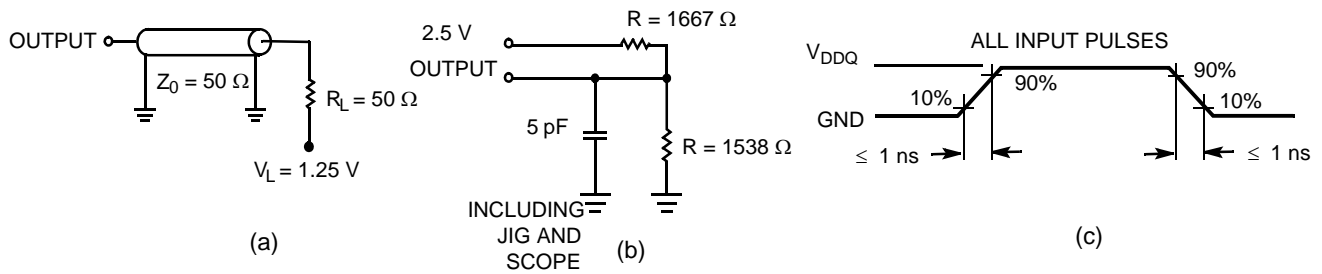

Switching Characteristics

Over the Operating Range

Parameter [27, 28]	Description	-200		-167		Unit
		Min	Max	Min	Max	
$t_{Power}^{[29]}$	$V_{CC(ypical)}$ to the first access read or write	1	–	1	–	ms
Clock						
t_{CYC}	Clock cycle time	5.0	–	6.0	–	ns
F_{MAX}	Maximum operating frequency	–	200	–	167	MHz
t_{CH}	Clock HIGH	2.0	–	2.2	–	ns
t_{CL}	Clock LOW	2.0	–	2.2	–	ns
Output Times						
t_{CO}	Data output valid after CLK rise	–	3.0	–	3.4	ns
t_{OEV}	\overline{OE} LOW to output valid	–	3.0	–	3.4	ns
t_{DOH}	Data output hold after CLK rise	1.3	–	1.5	–	ns
t_{CHZ}	Clock to high Z [30, 31, 32]	–	3.0	–	3.4	ns
t_{CLZ}	Clock to low Z [30, 31, 32]	1.3	–	1.5	–	ns
t_{EOHZ}	\overline{OE} HIGH to output high Z [30, 31, 32]	–	3.0	–	3.4	ns
t_{EOLZ}	\overline{OE} LOW to output low Z [30, 31, 32]	0	–	0	–	ns
Setup Times						
t_{AS}	Address setup before CLK rise	1.4	–	1.5	–	ns
t_{DS}	Data input setup before CLK rise	1.4	–	1.5	–	ns
t_{CENS}	\overline{CEN} setup before CLK rise	1.4	–	1.5	–	ns
t_{WES}	\overline{WE} , \overline{BW}_x setup before CLK rise	1.4	–	1.5	–	ns
t_{ALS}	$\overline{ADV/LD}$ setup before CLK rise	1.4	–	1.5	–	ns
t_{CES}	Chip select setup	1.4	–	1.5	–	ns
Hold Times						
t_{AH}	Address hold after CLK rise	0.4	–	0.5	–	ns
t_{DH}	Data input hold after CLK rise	0.4	–	0.5	–	ns
t_{CENH}	\overline{CEN} hold after CLK rise	0.4	–	0.5	–	ns
t_{WEH}	\overline{WE} , \overline{BW}_x hold after CLK rise	0.4	–	0.5	–	ns
t_{ALH}	$\overline{ADV/LD}$ hold after CLK rise	0.4	–	0.5	–	ns
t_{CEH}	Chip select hold after CLK rise	0.4	–	0.5	–	ns

Notes

27. Timing reference is 1.5 V when $V_{DDQ} = 3.3$ V and is 1.25 V when $V_{DDQ} = 2.5$ V.

28. Test conditions shown in (a) of Figure 4 on page 26 unless otherwise noted.

29. This part has a voltage regulator internally; t_{Power} is the time power needs to be supplied above $V_{DD(minimum)}$ initially, before a read or write operation can be initiated.

30. t_{CHZ} , t_{CLZ} , t_{EOLZ} , and t_{EOHZ} are specified with AC test conditions shown in (b) of Figure 4 on page 26. Transition is measured ± 200 mV from steady-state voltage.

31. At any voltage and temperature, t_{EOHZ} is less than t_{EOLZ} and t_{CHZ} is less than t_{CLZ} to eliminate bus contention between SRAMs when sharing the same data bus. These specifications do not imply a bus contention condition, but reflect parameters guaranteed over worst case user conditions. Device is designed to achieve high Z prior to low Z under the same system conditions.

32. This parameter is sampled and not 100% tested.

Switching Waveforms

Figure 5. Read/Write/Timing [33, 34, 35]

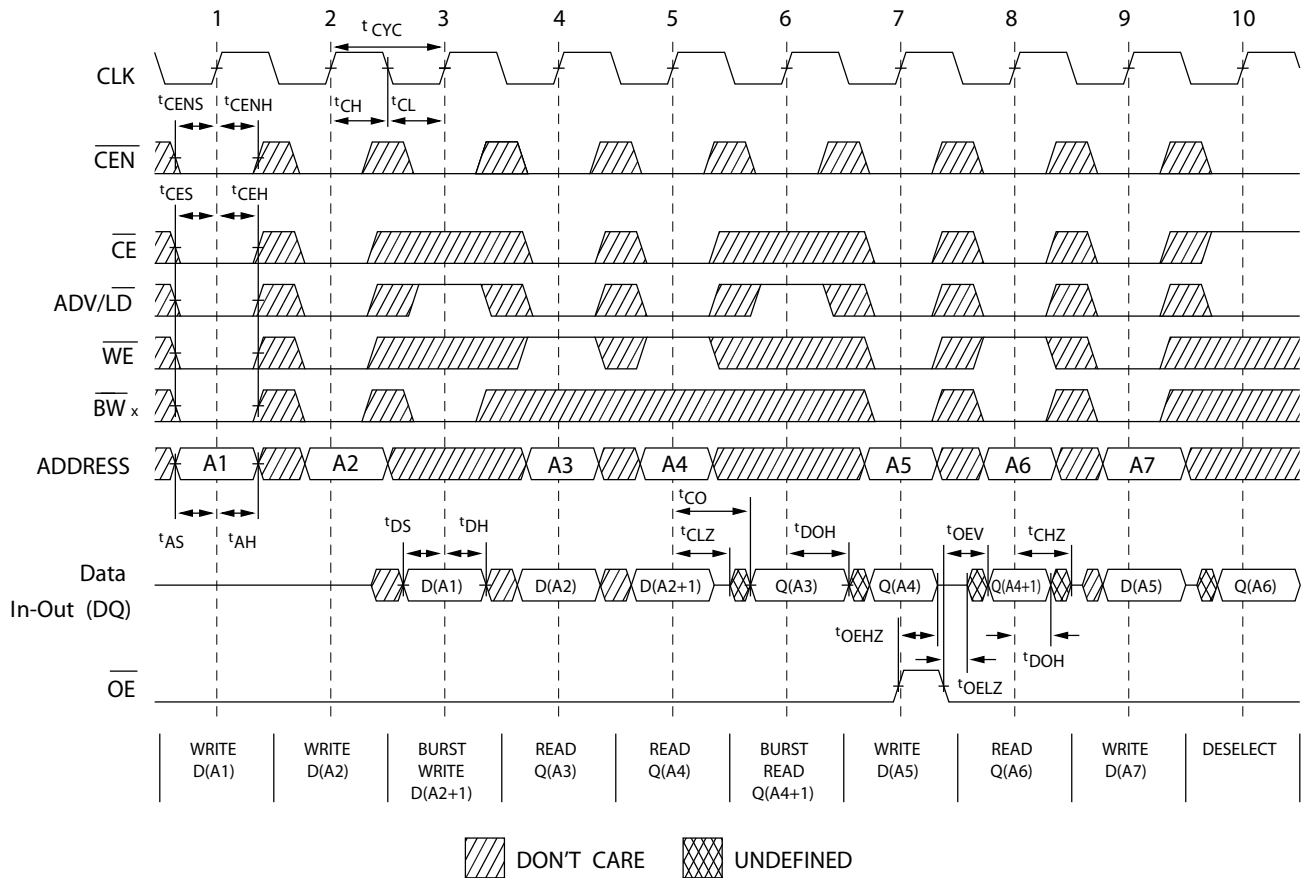

Notes

- 33. For this waveform ZZ is tied LOW.
- 34. When \overline{CE} is LOW, \overline{CE}_1 is LOW, \overline{CE}_2 is HIGH and \overline{CE}_3 is LOW. When \overline{CE} is HIGH, \overline{CE}_1 is HIGH or \overline{CE}_2 is LOW or \overline{CE}_3 is HIGH.
- 35. Order of the burst sequence is determined by the status of the MODE (0 = Linear, 1 = Interleaved). Burst operations are optional.

Switching Waveforms (continued)

Figure 6. NOP, STALL and DESELECT Cycles [36, 37, 38]

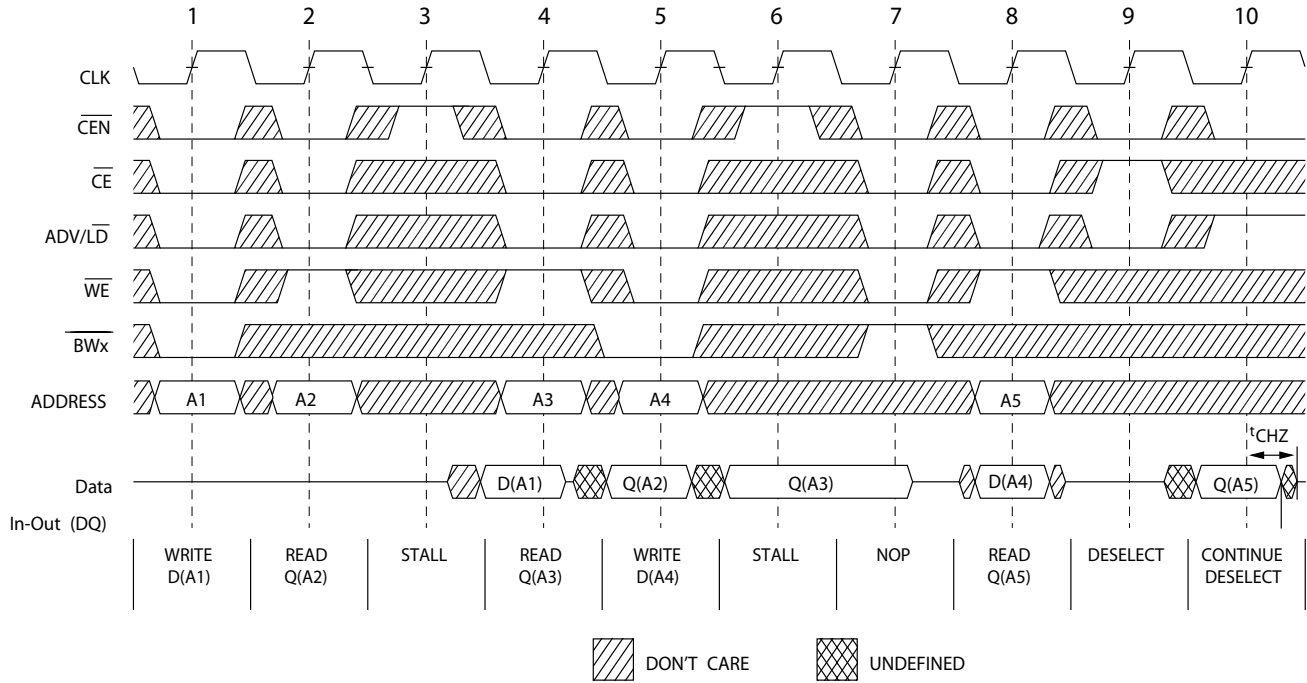
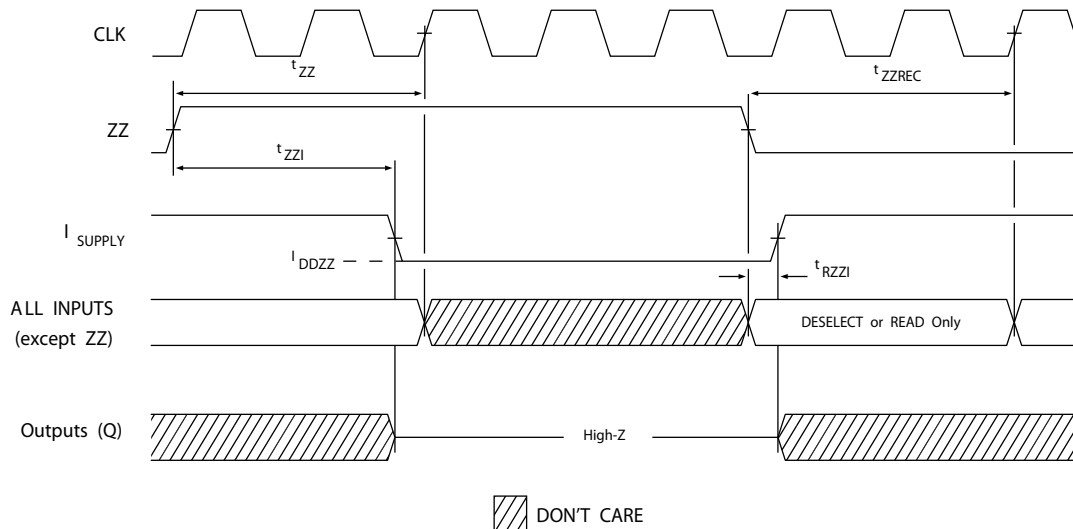

Figure 7. ZZ Mode Timing [39, 40]



Notes

- 36. For this waveform ZZ is tied LOW.
- 37. When \overline{CE} is LOW, \overline{CE}_1 is LOW, \overline{CE}_2 is HIGH and \overline{CE}_3 is LOW. When \overline{CE} is HIGH, \overline{CE}_1 is HIGH or \overline{CE}_2 is LOW or \overline{CE}_3 is HIGH.
- 38. The IGNORE CLOCK EDGE or STALL cycle (Clock 3) illustrated CEN being used to create a pause. A write is not performed during this cycle.
- 39. Device must be deselected when entering ZZ mode. See cycle description table for all possible signal conditions to deselect the device.
- 40. I/Os are in high Z when exiting ZZ sleep mode.

Ordering Information

The table below contains only the parts that are currently available. If you don't see what you are looking for, please contact your local sales representative. For more information, visit the Cypress website at www.cypress.com and refer to the product summary page at <http://www.cypress.com/products>

Cypress maintains a worldwide network of offices, solution centers, manufacturer's representatives and distributors. To find the office closest to you, visit us at <http://www.cypress.com/go/datasheet/offices>

Speed (MHz)	Ordering Code	Package Diagram	Part and Package Type	Operating Range
167	CY7C1470V33-167AXC	51-85050	100-pin TQFP (14 x 20 x 1.4 mm) Pb-free	Commercial
	CY7C1470V33-167BZC	51-85165	165-ball FBGA (15 x 17 x 1.4mm)	
	CY7C1474V33-167BGC	51-85167	209-ball FBGA (14 x 22 x 1.76 mm)	
	CY7C1470V33-167AXI	51-85050	100-pin TQFP (14 x 20 x 1.4 mm) Pb-free	Industrial
	CY7C1470V33-167BZI	51-85165	165-ball FBGA (15 x 17 x 1.4mm)	
200	CY7C1470V33-200AXC	51-85050	100-pin TQFP (14 x 20 x 1.4 mm) Pb-free	Commercial
	CY7C1472V33-200AXC			
	CY7C1474V33-200BGC	51-85167	209-ball FBGA (14 x 22 x 1.76 mm)	Industrial
	CY7C1470V33-200BZI	51-85165	165-ball FBGA (15 x 17 x 1.4mm)	

Ordering Code Definitions

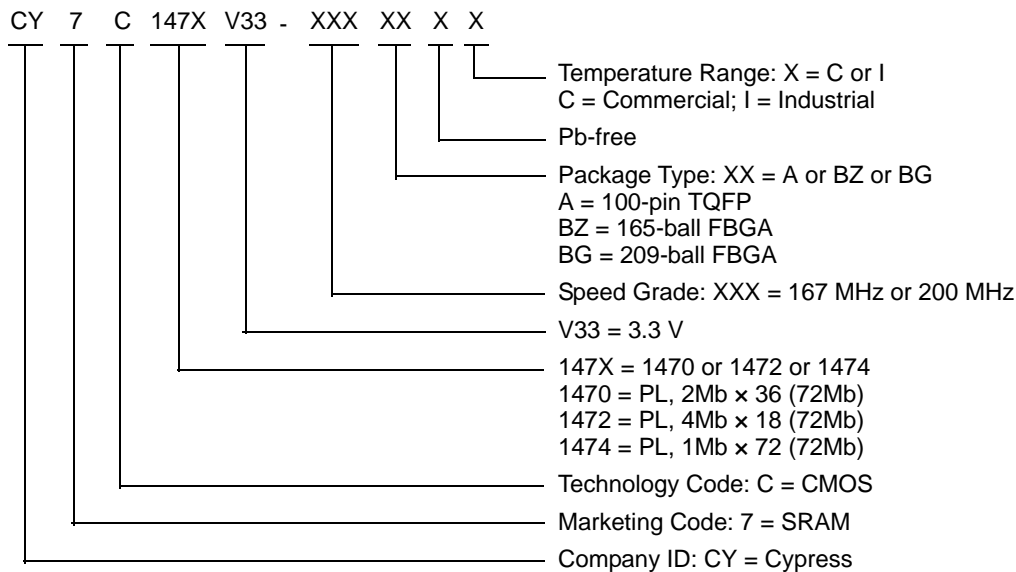

Package Diagrams

Figure 8. 100-pin TQFP (16 × 22 × 1.6 mm) A100RA Package Outline, 51-85050

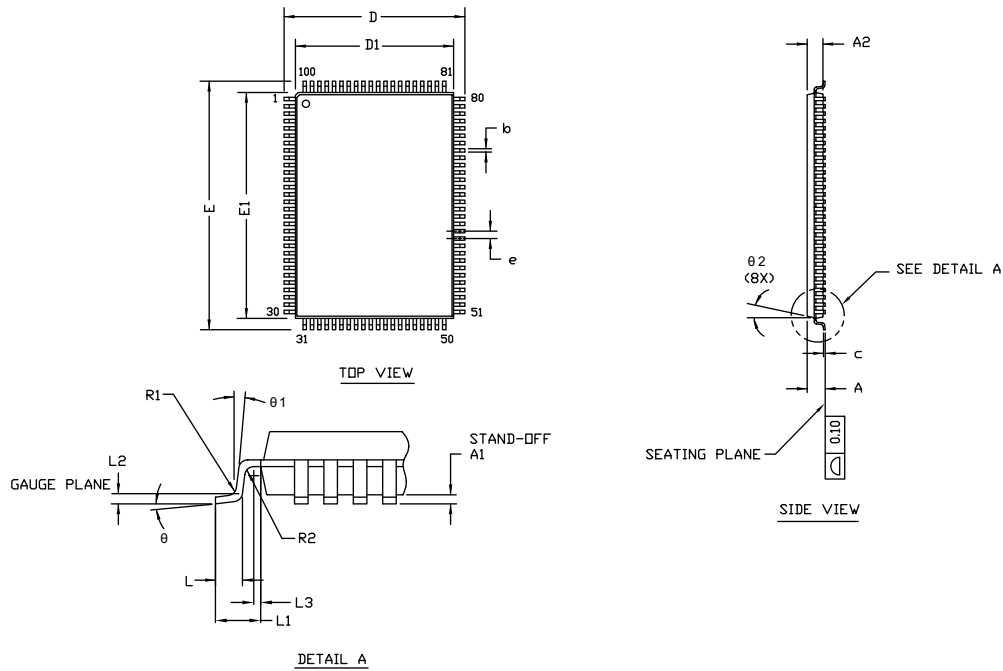

SYMBOL	DIMENSIONS		
	MIN.	NOM.	MAX.
A	—	—	1.60
A1	0.05	—	0.15
A2	1.35	1.40	1.45
D	15.80	16.00	16.20
D1	13.90	14.00	14.10
E	21.80	22.00	22.20
E1	19.90	20.00	20.10
R1	0.08	—	0.20
R2	0.08	—	0.20
θ	0°	—	7°
θ1	0°	—	—
θ2	11°	12°	13°
c	—	—	0.20
b	0.22	0.30	0.38
L	0.45	0.60	0.75
L1	1.00 REF		
L2	0.25 BSC		
L3	0.20	—	—
e	0.65 TYP		

- NOTE:
1. ALL DIMENSIONS ARE IN MILLIMETERS.
 2. BODY LENGTH DIMENSION DOES NOT INCLUDE MOLD PROTRUSION/END FLASH. MOLD PROTRUSION/END FLASH SHALL NOT EXCEED 0.0098 in (0.25 mm) PER SIDE. BODY LENGTH DIMENSIONS ARE MAX PLASTIC BODY SIZE INCLUDING MOLD MISMATCH.
 3. JEDEC SPECIFICATION NO. REF: MS-026.

51-85050 *F

Package Diagrams (continued)

Figure 9. 165-ball FBGA (15 × 17 × 1.40 mm) (0.45 Ball Diameter) Package Outline, 51-85165

NOTES:
 SOLDER PAD TYPE: SOLDER MASK DEFINED (SMD)
 PACKAGE WEIGHT: 0.60g
 JEDEC REFERENCE: MQ-216 / ISSUE E
 PACKAGE CODES: BB0AA / BW0AG

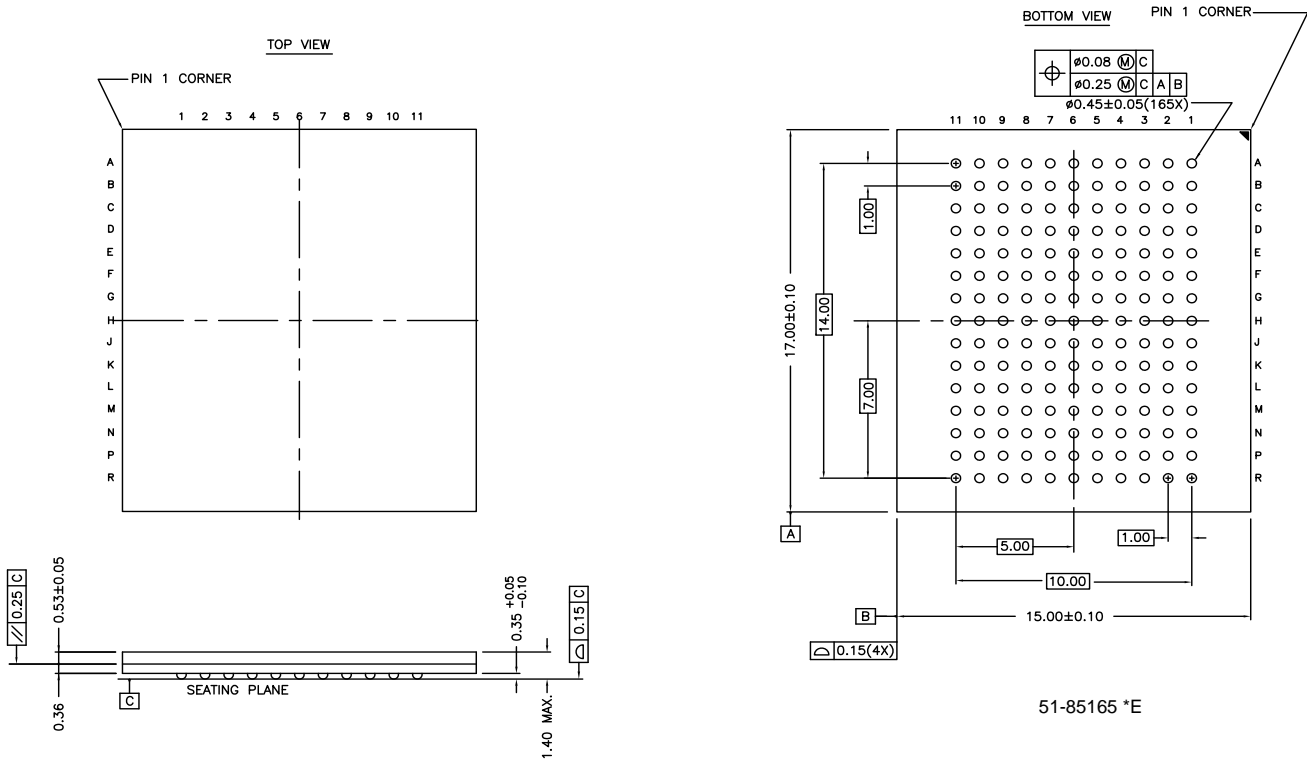

51-85165 *E

Package Diagrams (continued)

Figure 10. 209-ball FBGA (14 x 22 x 1.76 mm) BB209A Package Outline, 51-85167

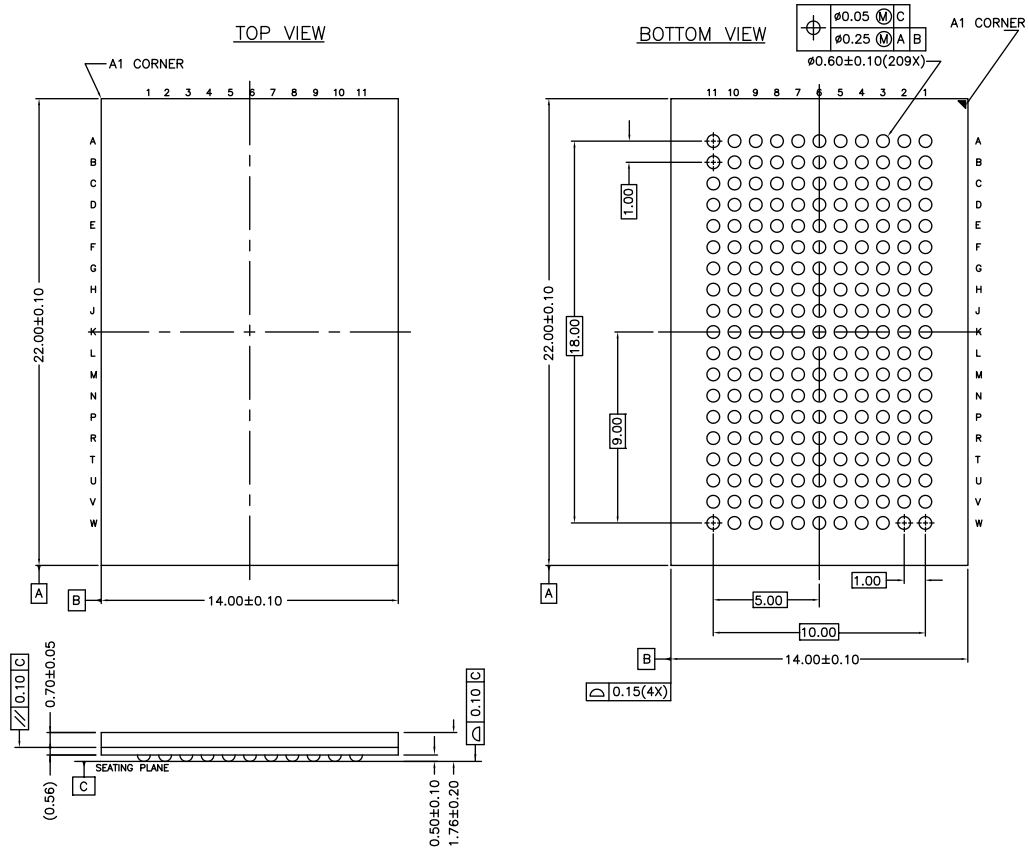

51-85167 *C

Acronyms

Acronym	Description
BGA	Ball Grid Array
CMOS	Complementary Metal Oxide Semiconductor
\overline{CE}	Chip Enable
\overline{CEN}	Clock Enable
FBGA	Fine-Pitch Ball Grid Array
I/O	Input/Output
JTAG	Joint Test Action Group
NoBL	No Bus Latency
\overline{OE}	Output Enable
SRAM	Static Random Access Memory
TCK	Test Clock
TDI	Test Data Input
TMS	Test Mode Select
TDO	Test Data Output
TQFP	Thin Quad Flat Pack
\overline{WE}	Write Enable

Document Conventions

Units of Measure

Symbol	Unit of Measure
°C	degree Celsius
MHz	megahertz
μA	microampere
mA	milliampere
mm	millimeter
ms	millisecond
ns	nanosecond
pF	picofarad
V	volt
W	watt

Errata

This section describes the Ram9 NoBL ZZ pin issues. Details include trigger conditions, the devices affected, proposed workaround and silicon revision applicability. Please contact your local Cypress sales representative if you have further questions.

Part Numbers Affected

Density & Revision	Package Type	Operating Range
72Mb-Ram9 NoBL SRAMs: CY7C147*V33	100-pin TQFP	Commercial/ Industrial
	165-ball FBGA	
	209-ball FBGA	Commercial

Product Status

All of the devices in the Ram9 72Mb NoBL family are qualified and available in production quantities.

Ram9 NoBL ZZ Pin Issues Errata Summary

The following table defines the errata applicable to available Ram9 72Mb NoBL family devices.

Item	Issues	Description	Device	Fix Status
1.	ZZ Pin	When asserted HIGH, the ZZ pin places device in a “sleep” condition with data integrity preserved. The ZZ pin currently does not have an internal pull-down resistor and hence cannot be left floating externally by the user during normal mode of operation.	72M-Ram9 (90 nm)	For the 72M Ram9 (90 nm) devices, this issue was fixed in the new revision. Please contact your local sales rep for availability.

1. ZZ Pin Issue

■ PROBLEM DEFINITION

The problem occurs only when the device is operated in the normal mode with ZZ pin left floating. The ZZ pin on the SRAM device does not have an internal pull-down resistor. Switching noise in the system may cause the SRAM to recognize a HIGH on the ZZ input, which may cause the SRAM to enter sleep mode. This could result in incorrect or undesirable operation of the SRAM.

■ TRIGGER CONDITIONS

Device operated with ZZ pin left floating.

■ SCOPE OF IMPACT

When the ZZ pin is left floating, the device delivers incorrect data.

■ WORKAROUND

Tie the ZZ pin externally to ground.

■ FIX STATUS

Fix was done for the 72M RAM9 NoBL SRAMs devices. Fixed devices have a new revision. The following table lists the devices affected and the new revision after the fix.

Table 1. List of Affected Devices and the new revision

Revision before the Fix	New Revision after the Fix
CY7C147*V33	CY7C147*BV33

Document History Page

Document Title: CY7C1470V33/CY7C1472V33/CY7C1474V33, 72-Mbit (2M x 36/4M x 18/1M x 72) Pipelined SRAM with NoBL™ Architecture				
Document Number: 38-05289				
Rev.	ECN	Submission Date	Orig. of Change	Description of Change
**	114676	08/06/02	PKS	New data sheet.
*A	121520	01/27/03	CJM	<p>Changed status from Advanced Information to Preliminary.</p> <p>Updated Features (For package offering, removed 300 MHz frequency related information).</p> <p>Updated Selection Guide (Removed 300 MHz frequency related information).</p> <p>Updated Functional Overview (Removed 300 MHz frequency related information).</p> <p>Updated Electrical Characteristics (Removed 300 MHz frequency related information).</p> <p>Updated Switching Characteristics (Removed 300 MHz frequency related information, changed maximum value of t_{CO}, t_{EOV}, t_{CHZ}, t_{EOHZ} parameters from 2.4 ns to 2.6 ns for 250 MHz frequency, changed minimum value of t_{DOH}, t_{CLZ} parameters from 0.8 ns to 1.0 ns for 250 MHz frequency, changed minimum value of t_{DOH}, t_{CLZ} parameters from 1.0 ns to 1.3 ns for 200 MHz frequency).</p> <p>Updated Ordering Information (Updated part numbers).</p>
*B	223721	See ECN	NJY	<p>Updated Features (Removed 250 MHz frequency related information and included 225 MHz frequency related information).</p> <p>Updated Functional Description (description).</p> <p>Updated Logic Block Diagram (Splitted Logic Block Diagram into three Logic Block Diagrams).</p> <p>Updated Functional Overview (description).</p> <p>Updated Boundary Scan Exit Order (Replaced TBD with values for all packages).</p> <p>Updated Electrical Characteristics (Removed 250 MHz frequency related information and included 225 MHz frequency related information, replaced TBD with values for maximum values of I_{DD}, I_{SB1}, I_{SB2}, I_{SB3}, I_{SB4} parameters).</p> <p>Updated Capacitance (Replaced TBD with values for all packages).</p> <p>Updated Thermal Resistance (Replaced TBD with values for all packages).</p> <p>Updated Switching Characteristics (Removed 250 MHz frequency related information and included 225 MHz frequency related information).</p> <p>Updated Switching Waveforms.</p> <p>Updated Package Diagrams (spec 51-85165 (Changed revision from ** to *A) for 165-ball FBGA package, removed 119-ball BGA package (spec 51-85115), removed spec 51-85143 and included spec 51-85167 for 209-ball BGA package).</p>
*C	235012	See ECN	RYQ	Minor Change (To match on the spec system and external web).
*D	243572	See ECN	NJY	<p>Updated Pin Configurations (Updated Figure 2 (Changed ball C11, D11, E11, F11, G11 from DQP_b, DQ_b, DQ_b, DQ_b, DQ_b to DQP_a, DQ_a, DQ_a, DQ_a, DQ_a (corresponding to CY7C1472V33))).</p> <p>Updated Capacitance (Splitted C_{IN} parameter into $C_{ADDRESS}$, C_{DATA}, C_{CLK} parameters and also updated the values).</p>

Document History Page (continued)

Document Title: CY7C1470V33/CY7C1472V33/CY7C1474V33, 72-Mbit (2M × 36/4M × 18/1M × 72) Pipelined SRAM with NoBL™ Architecture Document Number: 38-05289				
Rev.	ECN	Submission Date	Orig. of Change	Description of Change
*E	299511	See ECN	SYT / VBL	Updated Features (Removed 225 MHz frequency related information and included 250 MHz frequency related information). Updated Selection Guide (Removed 225 MHz frequency related information and included 250 MHz frequency related information). Updated Electrical Characteristics (Removed 225 MHz frequency related information and included 250 MHz frequency related information). Updated Thermal Resistance (Changed value of Θ_{JA} from 16.8 °C/W to 24.63 °C/W, and changed value of Θ_{JC} from 3.3 °C/W to 2.28 °C/W for 100-pin TQFP Package). Updated Switching Characteristics (Removed 225 MHz frequency related information and included 250 MHz frequency related information, changed minimum value of t_{CYC} from 4.4 ns to 4.0 ns for 250 MHz frequency). Updated Ordering Information (Updated part numbers (Removed 225 MHz frequency related information and included 250 MHz frequency related information, added Pb-free information for 100-pin TQFP Package and 165-ball FBGA Package, added Industrial Temperature Range part numbers), added comment of 'Pb-free BG packages availability' below the Ordering Information).
*F	323039	See ECN	PCI	Changed status from Preliminary to Final. Updated Selection Guide (Unshaded 250 MHz frequency related information). Updated Pin Configurations (Address expansion pins/balls in the pinouts for all packages are modified as per JEDEC standard, updated Figure 3 (Changed package name from 209-ball PBGA to 209-ball FBGA)). Updated Pin Definitions (Added Address Expansion pins). Updated Electrical Characteristics (Updated Test Conditions of V_{OL} , V_{OH} parameters, unshaded 250 MHz frequency related information). Updated Switching Characteristics (Unshaded 250 MHz frequency related information). Updated Ordering Information (Updated part numbers, unshaded all shaded areas, removed comment of 'Pb-free BG packages availability' below the Ordering Information).
*G	351937	See ECN	PCI	Updated Ordering Information (Updated part numbers).
*H	416221	See ECN	RXU	Changed address of Cypress Semiconductor Corporation from "3901 North First Street" to "198 Champion Court". Updated Electrical Characteristics (Updated Note 25 (Changed $V_{DDQ} < V_{DD}$ to $V_{DDQ} \leq V_{DD}$), changed description of I_X parameter from Input Load Current except ZZ and MODE to Input Leakage Current except ZZ and MODE, changed minimum value of I_X parameter (corresponding to Input Current of MODE (Input = V_{SS})) from -5 μ A to -30 μ A, changed maximum value of I_X parameter (corresponding to Input Current of MODE (Input = V_{DD})) from 30 μ A to 5 μ A, changed minimum value of I_X parameter (corresponding to Input Current of ZZ (Input = V_{SS})) from -30 μ A to -5 μ A, changed maximum value of I_X parameter (corresponding to Input Current of ZZ (Input = V_{DD})) from 5 μ A to 30 μ A). Updated Ordering Information (Updated part numbers, replaced Package Name column with Package Diagram in the Ordering Information table). Replaced Three-state with Tri-state in all instances across the document.

Document History Page *(continued)*

Document Title: CY7C1470V33/CY7C1472V33/CY7C1474V33, 72-Mbit (2M × 36/4M × 18/1M × 72) Pipelined SRAM with NoBL™ Architecture Document Number: 38-05289				
Rev.	ECN	Submission Date	Orig. of Change	Description of Change
*I	472335	See ECN	VKN	Updated Pin Configurations (Updated Figure 3 (Corrected the ball name for H9 from V _{SSQ} to V _{SS})). Updated TAP AC Switching Characteristics (Changed minimum value of t _{TH} , t _{TL} parameters from 25 ns to 20 ns, changed maximum value of t _{TDOV} parameter from 5 ns to 10 ns). Updated Maximum Ratings (Added Maximum Rating for Supply Voltage on V _{DDQ} Relative to GND). Updated Ordering Information (Updated part numbers).
*J	2756998	08/28/09	VKN	Added Neutron Soft Error Immunity . Updated Ordering Information (Updated part numbers (Including parts that are available), and modified the disclaimer for the Ordering information). Updated Package Diagrams (spec 51-85165 (Changed revision from *A to *B)).
*K	2903057	04/01/2010	NJY	Updated Ordering Information (Updated part numbers). Updated Package Diagrams .
*L	3033272	09/19/2010	NJY	Added Ordering Code Definitions . Added Acronyms and Units of Measure . Minor edits. Updated to new template.
*M	3052882	10/08/2010	NJY	Updated Ordering Information (Removed obsolete parts).
*N	3357114	08/29/2011	PRIT	Updated Package Diagrams .
*O	3403584	10/12/2011	PRIT	Updated Ordering Information (Removed prune part number CY7C1472V33-167AXI). Updated Package Diagrams .
*P	3638614	06/06/2012	PRIT	Updated Features (Removed 250 MHz frequency related information, removed 165-ball FBGA package related information (corresponding to CY7C1472V33)). Updated Selection Guide (Removed 250 MHz frequency related information). Updated Pin Configurations (Updated Figure 2 (Removed CY7C1472V33 related information)). Updated Functional Overview (Removed 250 MHz frequency related information). Updated IEEE 1149.1 Serial Boundary Scan (JTAG) (Removed CY7C1472V33 related information). Updated Identification Register Definitions (Removed CY7C1472V33 related information). Updated Scan Register Sizes (Removed "Bit Size (× 18)" column). Removed Boundary Scan Exit Order (Corresponding to CY7C1472V33). Updated Electrical Characteristics (Removed 250 MHz frequency related information). Updated Switching Characteristics (Removed 250 MHz frequency related information). Updated Ordering Information (Updated part numbers).
*Q	3755966	09/26/2012	PRIT	Updated Package Diagrams (spec 51-85167 (Changed revision from *B to *C)).
*R	3971410	04/18/2013	PRIT	Updated Ordering Information (Updated part numbers). Added Errata .
*S	4042037	06/27/2013	PRIT	Added Errata Footnotes. Updated to new template.
*T	4146627	10/04/2013	PRIT	Updated Errata .

Document History Page *(continued)*

Document Title: CY7C1470V33/CY7C1472V33/CY7C1474V33, 72-Mbit (2M x 36/4M x 18/1M x 72) Pipelined SRAM with NoBL™ Architecture Document Number: 38-05289				
Rev.	ECN	Submission Date	Orig. of Change	Description of Change
*U	4539205	10/15/2014	PRIT	Updated Package Diagrams : spec 51-85050 – Changed revision from *D to *E. Completing Sunset Review.
*V	4571917	12/29/2014	PRIT	Updated Functional Description : Added “For a complete list of related documentation, click here .” at the end. Updated Package Diagrams : spec 51-85165 – Changed revision from *D to *E.
*W	5513955	11/08/2016	PRIT	Updated Package Diagrams : spec 51-85050 – Changed revision from *E to *F. Updated to new template. Completing Sunset Review.

Sales, Solutions, and Legal Information

Worldwide Sales and Design Support

Cypress maintains a worldwide network of offices, solution centers, manufacturer's representatives, and distributors. To find the office closest to you, visit us at [Cypress Locations](#).

Products

ARM® Cortex® Microcontrollers	cypress.com/arm
Automotive	cypress.com/automotive
Clocks & Buffers	cypress.com/clocks
Interface	cypress.com/interface
Internet of Things	cypress.com/iot
Lighting & Power Control	cypress.com/powerpsoc
Memory	cypress.com/memory
PSoC	cypress.com/psoc
Touch Sensing	cypress.com/touch
USB Controllers	cypress.com/usb
Wireless/RF	cypress.com/wireless

PSoC® Solutions

[PSoC 1](#) | [PSoC 3](#) | [PSoC 4](#) | [PSoC 5LP](#)

Cypress Developer Community

[Forums](#) | [Projects](#) | [Video](#) | [Blogs](#) | [Training](#) | [Components](#)

Technical Support

cypress.com/support

© Cypress Semiconductor Corporation, 2002-2016. This document is the property of Cypress Semiconductor Corporation and its subsidiaries, including Spansion LLC ("Cypress"). This document, including any software or firmware included or referenced in this document ("Software"), is owned by Cypress under the intellectual property laws and treaties of the United States and other countries worldwide. Cypress reserves all rights under such laws and treaties and does not, except as specifically stated in this paragraph, grant any license under its patents, copyrights, trademarks, or other intellectual property rights. If the Software is not accompanied by a license agreement and you do not otherwise have a written agreement with Cypress governing the use of the Software, then Cypress hereby grants you a personal, non-exclusive, nontransferable license (without the right to sublicense) (1) under its copyright rights in the Software (a) for Software provided in source code form, to modify and reproduce the Software solely for use with Cypress hardware products, only internally within your organization, and (b) to distribute the Software in binary code form externally to end users (either directly or indirectly through resellers and distributors), solely for use on Cypress hardware product units, and (2) under those claims of Cypress's patents that are infringed by the Software (as provided by Cypress, unmodified) to make, use, distribute, and import the Software solely for use with Cypress hardware products. Any other use, reproduction, modification, translation, or compilation of the Software is prohibited.

TO THE EXTENT PERMITTED BY APPLICABLE LAW, CYPRESS MAKES NO WARRANTY OF ANY KIND, EXPRESS OR IMPLIED, WITH REGARD TO THIS DOCUMENT OR ANY SOFTWARE OR ACCOMPANYING HARDWARE, INCLUDING, BUT NOT LIMITED TO, THE IMPLIED WARRANTIES OF MERCHANTABILITY AND FITNESS FOR A PARTICULAR PURPOSE. To the extent permitted by applicable law, Cypress reserves the right to make changes to this document without further notice. Cypress does not assume any liability arising out of the application or use of any product or circuit described in this document. Any information provided in this document, including any sample design information or programming code, is provided only for reference purposes. It is the responsibility of the user of this document to properly design, program, and test the functionality and safety of any application made of this information and any resulting product. Cypress products are not designed, intended, or authorized for use as critical components in systems designed or intended for the operation of weapons, weapons systems, nuclear installations, life-support devices or systems, other medical devices or systems (including resuscitation equipment and surgical implants), pollution control or hazardous substances management, or other uses where the failure of the device or system could cause personal injury, death, or property damage ("Unintended Uses"). A critical component is any component of a device or system whose failure to perform can be reasonably expected to cause the failure of the device or system, or to affect its safety or effectiveness. Cypress is not liable, in whole or in part, and you shall and hereby do release Cypress from any claim, damage, or other liability arising from or related to all Unintended Uses of Cypress products. You shall indemnify and hold Cypress harmless from and against all claims, costs, damages, and other liabilities, including claims for personal injury or death, arising from or related to any Unintended Uses of Cypress products.

Cypress, the Cypress logo, Spansion, the Spansion logo, and combinations thereof, WICED, PSoC, CapSense, EZ-USB, F-RAM, and Traveo are trademarks or registered trademarks of Cypress in the United States and other countries. For a more complete list of Cypress trademarks, visit cypress.com. Other names and brands may be claimed as property of their respective owners.