

ITEM NO.	PART NUMBER	DESCRIPTION	QTY.	COMPONENT NOTES
1	50-00024	Connector, dc plug, 5.5x2.1xL23 mm, molding style, spring contacts	1	
2	30-00007	Wire, 2C BC, 18 AWG, UL2468, 300V, 80C, 4.4 mm, VW-1, PVC, 87A	1	
3	24-00003	Overmold, PVC	1	black
4	24-00251	Overmold, strain relief, 7x5x2.5 mm bushing, 18 AWG, UL2468 wire	1	black

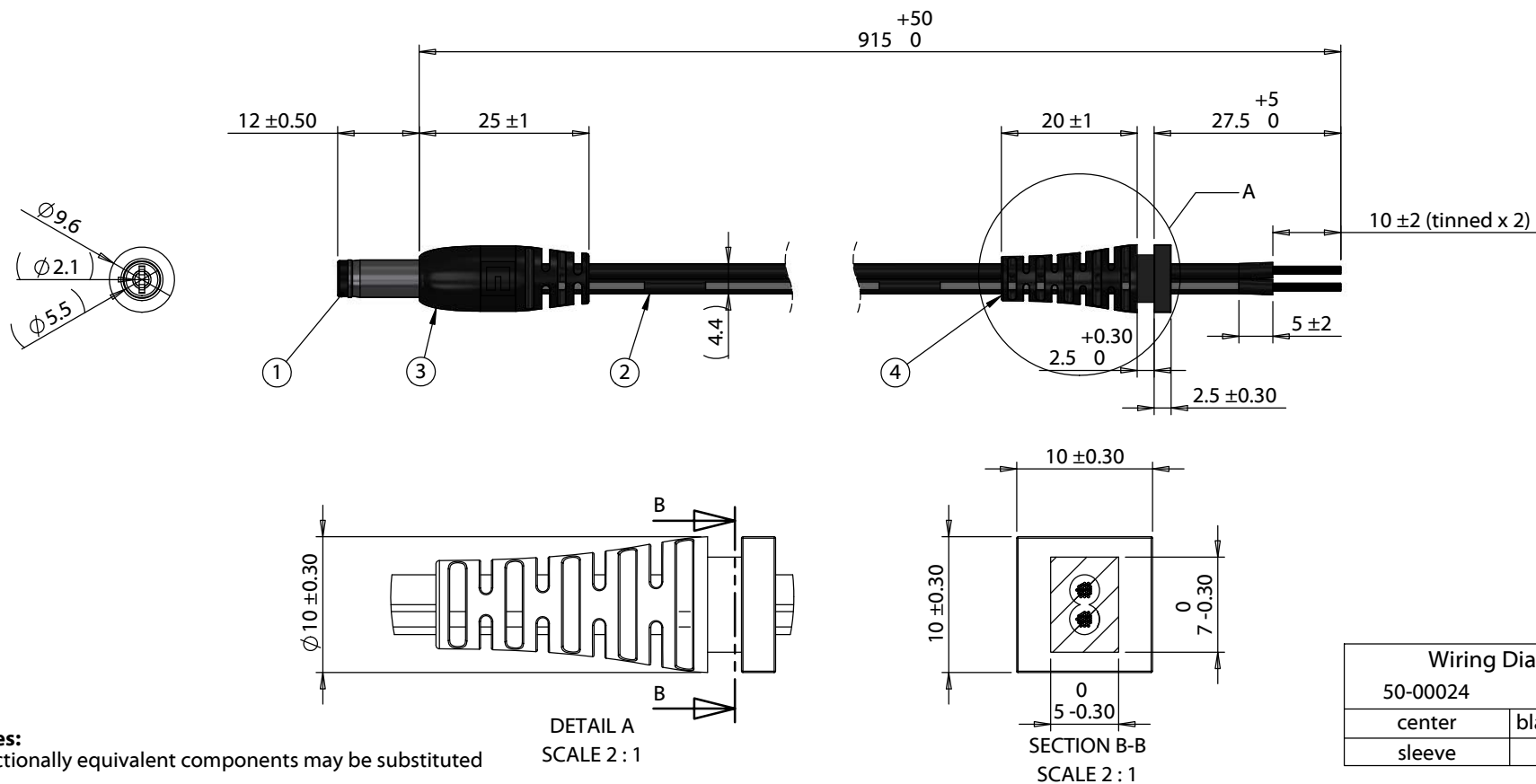

Notes:
Functionally equivalent components may be substituted

DETAIL A
SCALE 2 : 1

SECTION B-B
SCALE 2 : 1

Revision:	Date:	Description:	Prepared:	Notes: RoHS and REACH compliant Function test: no open, no short circuit, no intermittent	<h1>TENSILITY</h1> <p>tel 1.541.323.3228 800 877.670.7118 fax 1.541.323.4202 web tensility.com</p>
A	03/28/2018	Initial release	Verified:		
			Dimensions are in millimeters. Tolerances: X: ± 0.5 mm X.X: ± 0.3 mm X.XX: ± 0.05 mm	Description: Cable, 915 mm, 5.5x2.1x12 mm 50-00024 dc plug to strain relief 10 mm tinned, 18 AWG, UL2468 wire	Size: A
					Part number: 10-02954
					Scale: 1:1
					Sheet 1 of 1

5

4

3

2

1