

CARMEN-S-C

~14° spot beam. Assembly with holder C compatible with LEDiL HEKLA.

TECHNICAL SPECIFICATIONS:

Dimensions	Ø 69.5 mm
Height	41.5 mm
Fastening	socket
Colour	black
Box size	476 x 273 x 292 mm
Box weight	4.5 kg
Quantity in Box	150 pcs
ROHS compliant	yes ⓘ







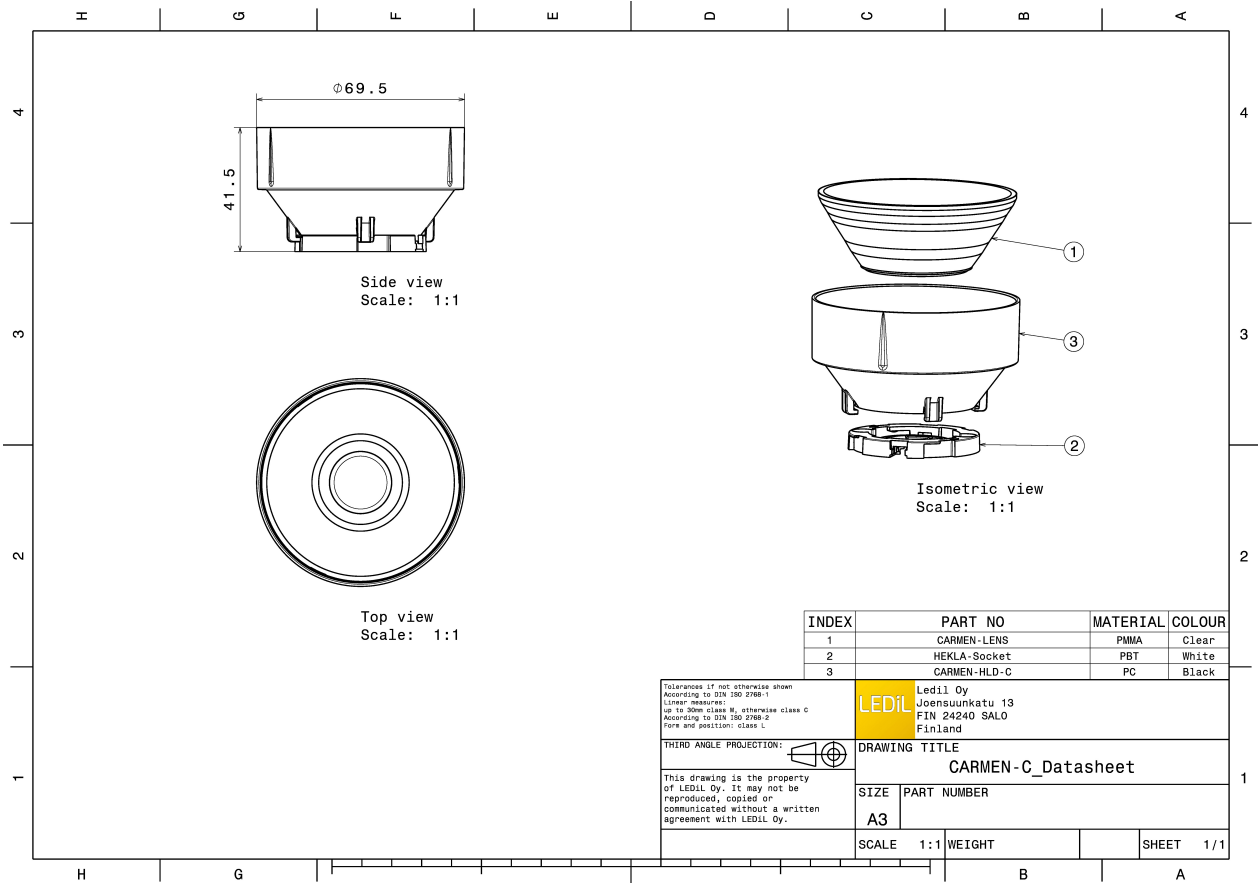

MATERIAL SPECIFICATIONS:

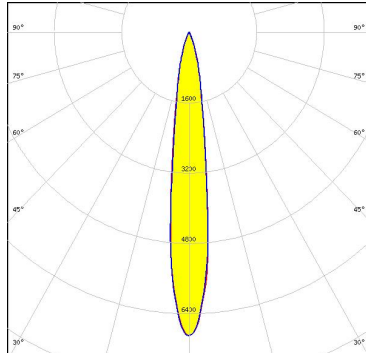
Component	Type	Material	Colour
CARMEN-S	Lens	PMMA	clear
CARMEN-HLD-C	Holder	PC	black

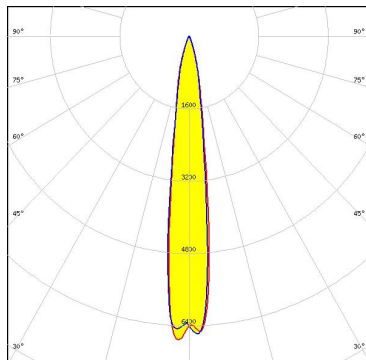

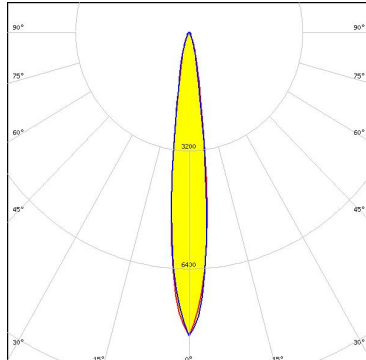
PHOTOMETRIC DATA (MEASURED):

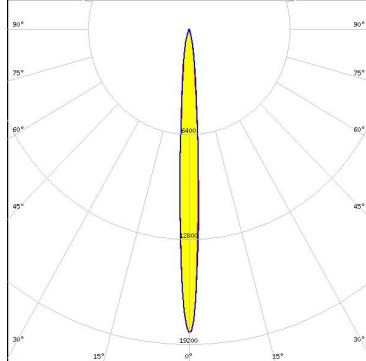
<p>bridgelux.</p> <p>LED VERO10</p> <p>FWHM 14.0°</p> <p>Efficiency 75 %</p> <p>Peak intensity 6.900 cd/lm</p> <p>Required components: F15616_HEKLA-SOCKET-F</p>		
<p>bridgelux.</p> <p>LED Vesta DTW 9mm (6W/12W)</p> <p>FWHM 14.0°</p> <p>Efficiency 71 %</p> <p>Peak intensity 6.800 cd/lm</p> <p>Required components: C16142_HEKLA-SOCKET-K Bender Wirth: 490 Typ L8</p>		
<p>CITIZEN</p> <p>LED CLL02x/CLU02x (LES10)</p> <p>FWHM 15.0°</p> <p>Efficiency 74 %</p> <p>Peak intensity 6.000 cd/lm</p> <p>Required components: F15255_HEKLA-SOCKET-C</p>		
<p>CITIZEN</p> <p>LED CLU LES 4.2mm (HI-Ver.3)</p> <p>FWHM 7.0°</p> <p>Efficiency 80 %</p> <p>Peak intensity 18.500 cd/lm</p> <p>Required components: F15255_HEKLA-SOCKET-C</p>		

PHOTOMETRIC DATA (MEASURED):

CITIZEN

LED CLU700/701
 FWHM 10.0°
 Efficiency 78 %
 Peak intensity 12.700 cd/lm
 Required components:
 F15255_HEKLA-SOCKET-C

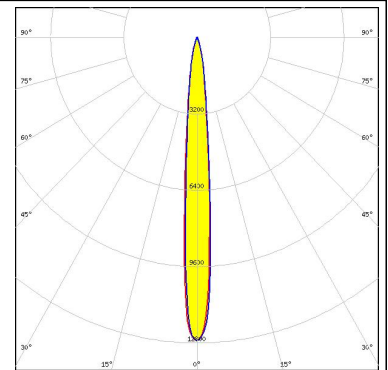
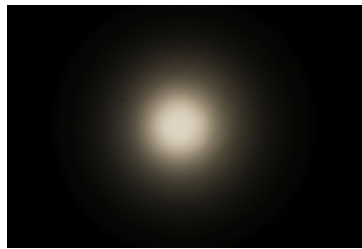

CREE

LED CMA1516
 FWHM 14.0°
 Efficiency 72 %
 Peak intensity 5.800 cd/lm
 Required components:
 F15256_HEKLA-SOCKET-D

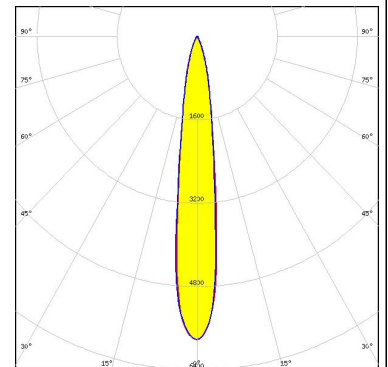
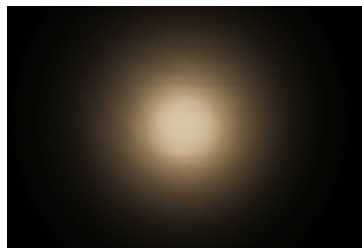

LUMILEDS

LED LUXEON CoB 1205HD
 FWHM 17.0°
 Efficiency 69 %
 Peak intensity 4.200 cd/lm
 Required components:
 F15858_HEKLA-SOCKET-H

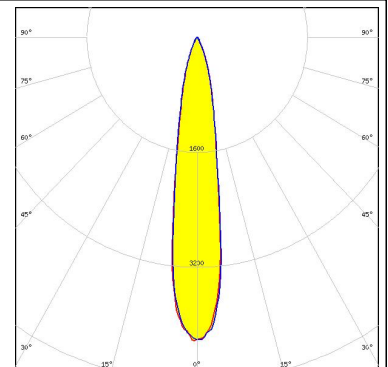
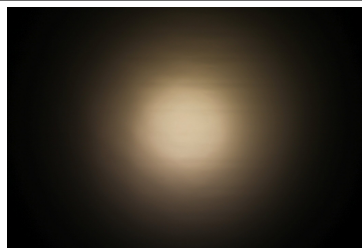

LUMINUS

LED CDM-9 (Dim-To-Warm)
 FWHM 14.0°
 Efficiency 71 %
 Peak intensity 6.700 cd/lm
 Required components:
 C16142_HEKLA-SOCKET-K
 Bender Wirth: 490 Typ L8

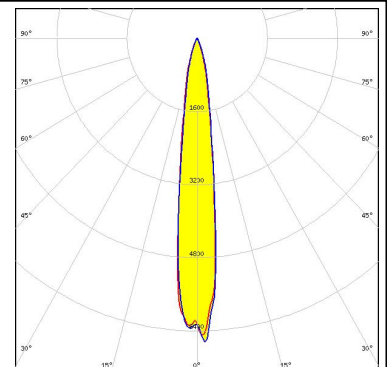
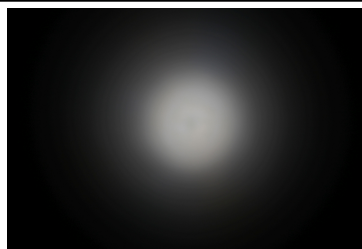

PHOTOMETRIC DATA (MEASURED):



LED CXM-9
FWHM 15.0°
Efficiency 74 %
Peak intensity 6.200 cd/lm
Required components:
F15255_HEKLA-SOCKET-C

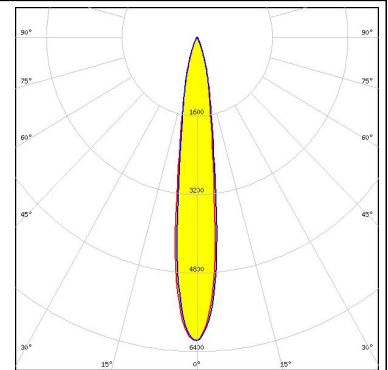

LED COB D Series LES 9.8 mm
FWHM 15.0°
Efficiency 74 %
Peak intensity 6.000 cd/lm
Required components:
F15255_HEKLA-SOCKET-C

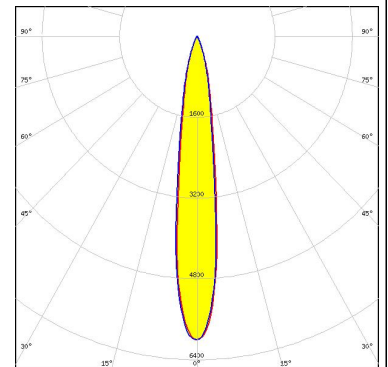
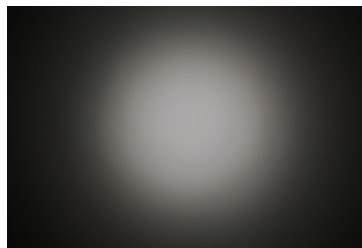

LED LC010C G2
FWHM 9.0°
Efficiency 77 %
Peak intensity 13.100 cd/lm
Required components:
F15255_HEKLA-SOCKET-C

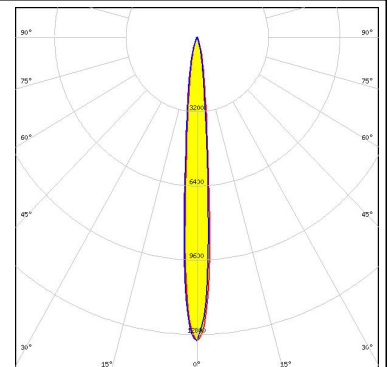
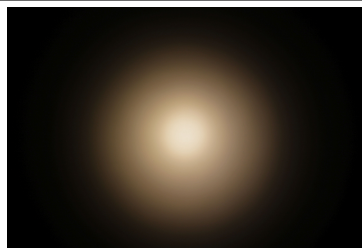



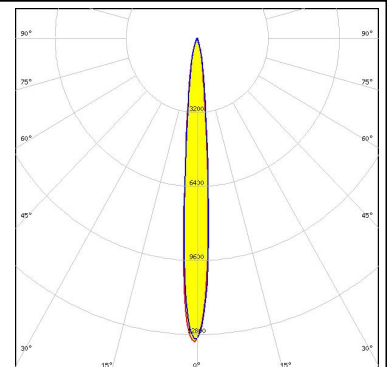

SEOUL SEMICONDUCTOR

LED MJT COB LES 6
FWHM 9.0°
Efficiency 76 %
Peak intensity 13.100 cd/lm
Required components:
F15255_HEKLA-SOCKET-C

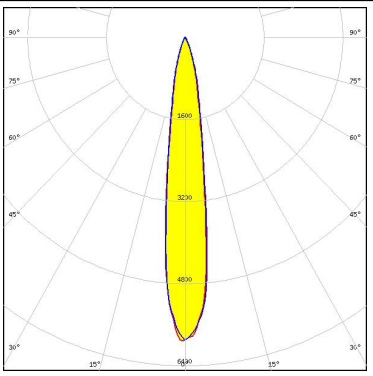

PHOTOMETRIC DATA (MEASURED):

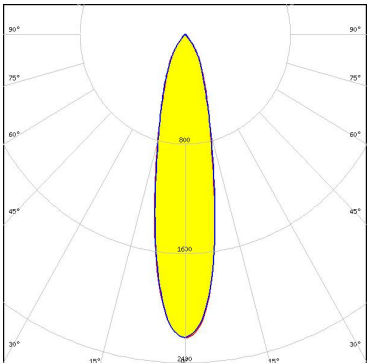
<p> SEOUL SEMICONDUCTOR</p> <p>LED MJT COB LES 9.8 FWHM 15.0° Efficiency 72 % Peak intensity 5.900 cd/lm Required components: F15255_HEKLA-SOCKET-C</p>		
<p>XICATO</p> <p>LED XTM - 19mm LES FWHM 23.0° Efficiency 66 % Peak intensity 2.200 cd/lm Required components: C16058_XTM-ADAPTER-50-C</p>		

PHOTOMETRIC DATA (SIMULATED):

CITIZEN

LED CLU700/701
FWHM 10.4°
Efficiency 0 %
Peak intensity 15.700 cd/lm
Required components:
F15255_HEKLA-SOCKET-C

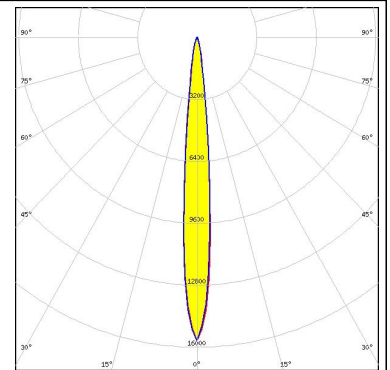

CREE

LED CXA/B 15xx
FWHM 12.9°
Efficiency 0 %
Peak intensity 9.460 cd/lm
Required components:
F15256_HEKLA-SOCKET-D

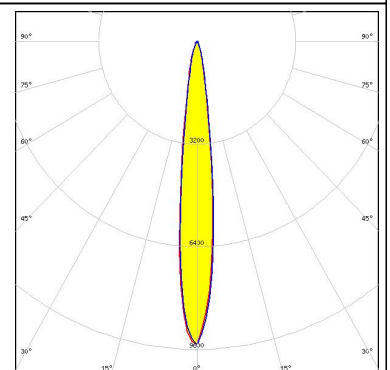

NICHIA

LED COB T-Type
FWHM 11.0°
Efficiency 78 %
Peak intensity 12.740 cd/lm
Required components:
F15848_HEKLA-SOCKET-G

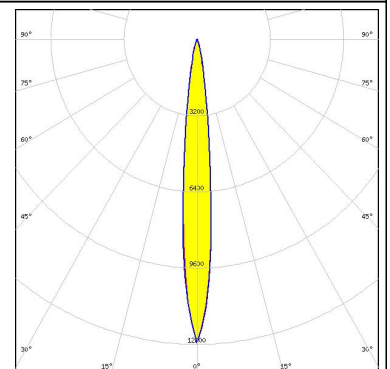

TRIDONIC

LED SLE G6 LES10
FWHM 14.0°
Efficiency 73 %
Peak intensity 8.100 cd/lm
Required components:
F15255_HEKLA-SOCKET-C

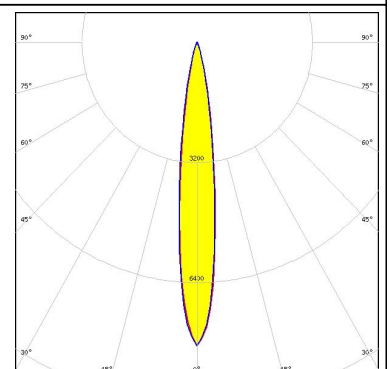

GENERAL INFORMATION:

NOTE: The typical beam angle will be changed by different color, chip size and chip position tolerance. The typical total beam angle is the full angle measured where the luminous intensity is half of the peak value.

Due to use of high power COB's with this product, special attention to proper thermal design is highly recommended. LEDiL has no liability for direct, indirect or consecutive damages arising from the LEDiL products being used outside of the recommended temperature range.

MATERIALS:

As part of our continuous research and improvement processes, and to ensure the best possible quality and availability of our products, LEDiL reserves the right to change material grades without notice.

PRODUCT DATA USER AGREEMENT AND DISCLAIMER:

The measured data in the provided downloadable LEDiL Product Datasheets and Mechanical 2D-Drawings is rounded and provided as reference for planning. LEDiL Oy's optical specifications have been verified by conducting performance testing of the products in accordance with the company's quality system. The reported data are averaged results of multiple measurements with typical variation. LEDiL Oy reserves the right to without prior notification make changes and improvements to its products.

LEDiL Oy assumes neither warranty, nor guarantee nor any other liability of any kind for the contents and correctness of the provided data. The provided data has been generated with highest diligence but the provided data may in reality not represent the complete possible variation range of all intrinsic parameters. Therefore, in certain cases a deviation from the provided data could occur.

LEDiL Oy reserves the right to undertake technical changes of its products without further notification which could lead to changes in the provided data. LEDiL Oy assumes no liability of any kind for the possible deviation from any provided data or any other damage resulting from the usage of the provided data.

The user agrees to this disclaimer and user agreement with the download or usage of the provided files.

LEDiL Oy

Joensuunkatu 13
FI-24240 SALO
Finland

LEDiL Inc.

228 West Page Street
Suite D
Sycamore IL 60178
USA

Local sales and technical support

www.ledil.com/where_to_buy

Shipping locations

Salo, Finland
Hong Kong, China

Distribution Partners

www.ledil.com/where_to_buy