

LPC-P1343 development board user's manual



All boards produced by Olimex are ROHS compliant

Revision C, February 2013
Copyright(c) 2011, OLIMEX Ltd, All rights reserved

INTRODUCTION

LPC-P1343 is a development board with LPC1343 ARM Cortex-M3 based microcontroller for embedded applications from NXP. LPC-P1343 featuring a high level of integration and low power consumption. This microcontroller supports various interfaces such as one Fast-mode Plus I²C-bus interface, USB, UART, SSP interfaces, four general purpose timers, a 10-bit ADC. On the board are available UEXT, Debug Interface, user buttons, USB device and user LEDs. This allows you to build a diversity of powerful software that can be used in a wide range of applications.

BOARD FEATURES

- MCU: **LPC1343** Cortex-M3, up to 70 MHz, 32 kB Flash, 8kB SRAM, UART RS-485, USB, SSP, I²C/Fast+, ADC
- Power supply circuit
- Power-on led
- USB connector and functionality
- USBC LED
- Debug interface - SWD (Serial Wire Debug)
- UEXT connector
- Eight user LEDs
- Two user buttons
- Reset button
- Prototype area
- FR-4, 1.5 mm, red soldermask, white component print
- Dimensions:80x50mm (3.15 x 1.97")

ELECTROSTATIC WARNING

The **LPC-P1343** board is shipped in protective anti-static packaging. The board must not be subject to high electrostatic potentials. General practice for working with static sensitive devices should be applied when working with this board.

BOARD USE REQUIREMENTS

Cables: The cable you will need depends on the programmer/debugger you use. For instance, if you use <https://www.olimex.com/Products/ARM/JTAG/ARM-JTAG-COOCOX/>, you will need USB A-B cable.

Hardware: Programmer/debugger or other compatible programming/debugging tool with SWD interface. The only Olimex programmer that has SWD interface at the moment is ARM-JTAG-COOCOX - <https://www.olimex.com/Products/ARM/JTAG/ARM-JTAG-COOCOX>.

OpenOCD debuggers (ARM-JTAG-TINY, ARM-JTAG-TINY-H, ARM-JTAG-OCD, ARM-JTAG-OCD-H) can also be adapted to work with SWD interface by getting <https://www.olimex.com/Products/ARM/JTAG/ARM-JTAG-SWD/>. NOTE that at the current moment only Rowley Crossworks supports this combination.

PROCESSOR FEATURES

LPC-P1343 board use ARM Cortex™-M3 microcontroller **LPC1343FBD48/301** from NXP Semiconductors with these features:

- ARM Cortex-M3 processor, running at frequencies of up to 72 MHz
- ARM Cortex-M3 built-in Nested Vectored Interrupt Controller (NVIC).
- 32kB on-chip flash programming memory. Enhanced flash memory accelerator enables high- speed 72 MHz operation with zero wait states
- In-System Programming (ISP) and In-Application Programming (IAP) via on-chip bootloader software.
- Serial interfaces:
 - USB 2.0 full-speed device controller with on-chip PHY for device
 - UART with fractional baud rate generation, modem, internal FIFO and RS-485/EIA-485 support.
 - SSP controller with FIFO and multi-protocol capabilities.
 - I²C-bus interface supporting full I²C-bus specification and Fast-mode Plus with a data rate of 1 Mbit/s with multiple address recognition and monitor mode.
- Other peripherals:
 - 42 General Purpose I/O (GPIO) pins with configurable pull-up/down resistors and a new, configurable open-drain operating mode.
 - Four general purpose timers/counters, with a total of four capture inputs and 13 match outputs.

- Programmable WatchDog Timer (WDT).
- System tick timer.
- Serial Wire Debug and Serial Wire Trace Port.
- High-current output driver (20 mA) on one pin.
- High-current sink drivers (20 mA) on two I2C-bus pins in Fast-mode Plus.
- Integrated PMU (Power Management Unit) to minimize power consumption during Sleep, Deep-sleep, and Deep power-down modes.
- Three reduced power modes: Sleep, Deep-sleep, and Deep power-down.
- Single 3.3 V power supply (2.0 V to 3.6 V).
- 10-bit ADC with input multiplexing among 8 pins.
- 40 GPIO pins can be used as edge and level sensitive interrupt sources.
- Clock output function with divider that can reflect the main oscillator clock, IRC clock, CPU clock, Watchdog clock, and the USB clock.
- Processor wake-up from Deep-sleep mode via GPIO interrupts.
- Brownout detect with four separate thresholds for interrupt and one threshold for forced reset.
- Power-On Reset (POR).
- Crystal oscillator with an operating range of 1 MHz to 25 MHz.
- 12 MHz internal RC oscillator trimmed to 1 % accuracy that can optionally be used as a system clock.
- PLL allows CPU operation up to the maximum CPU rate without the need for a high-frequency crystal. May be run from the main oscillator, the internal RC oscillator, or the Watchdog oscillator.
- Code Read Protection (CRP) with different security levels.

BLOCK DIAGRAM

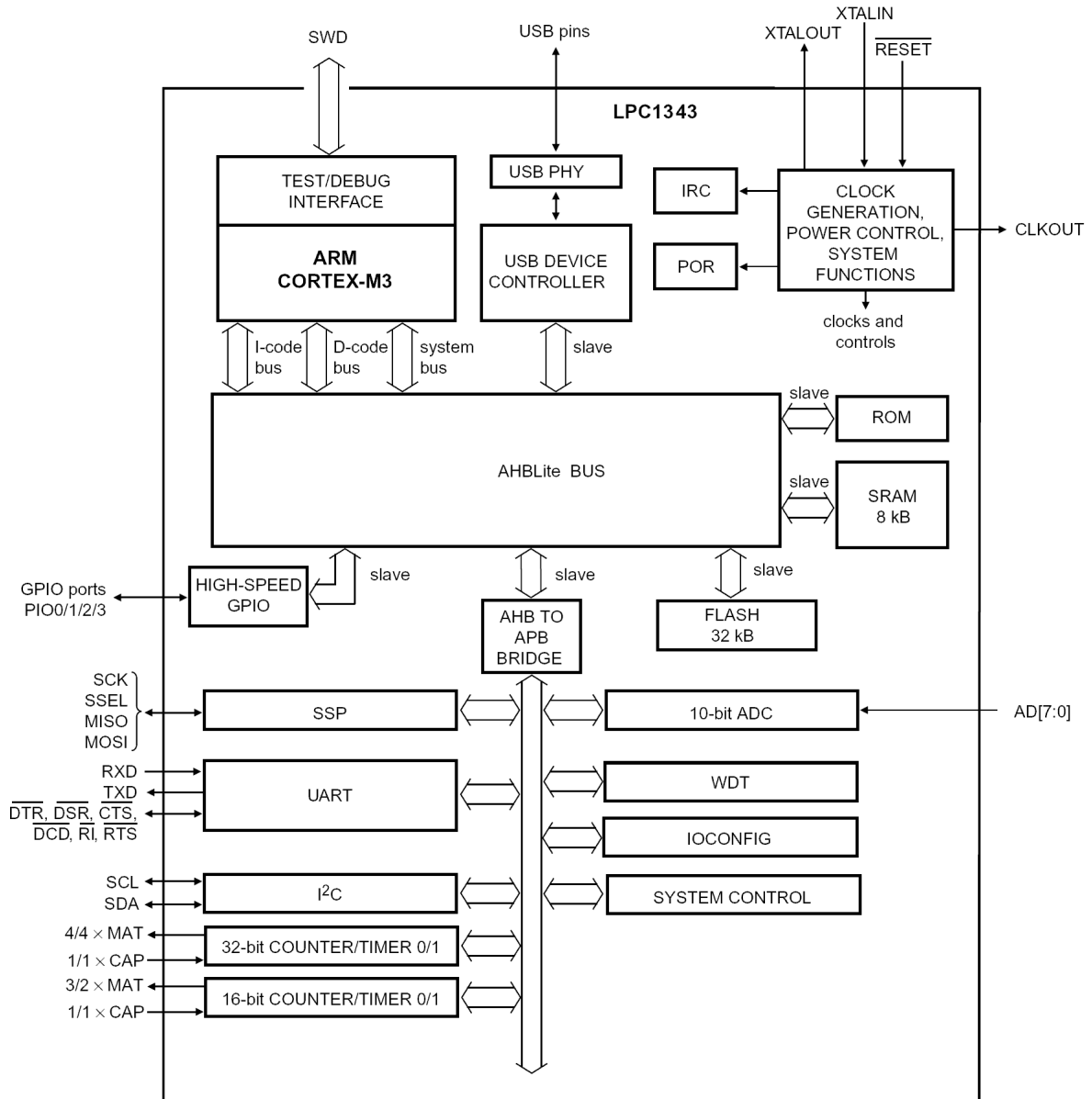

MEMORY MAP

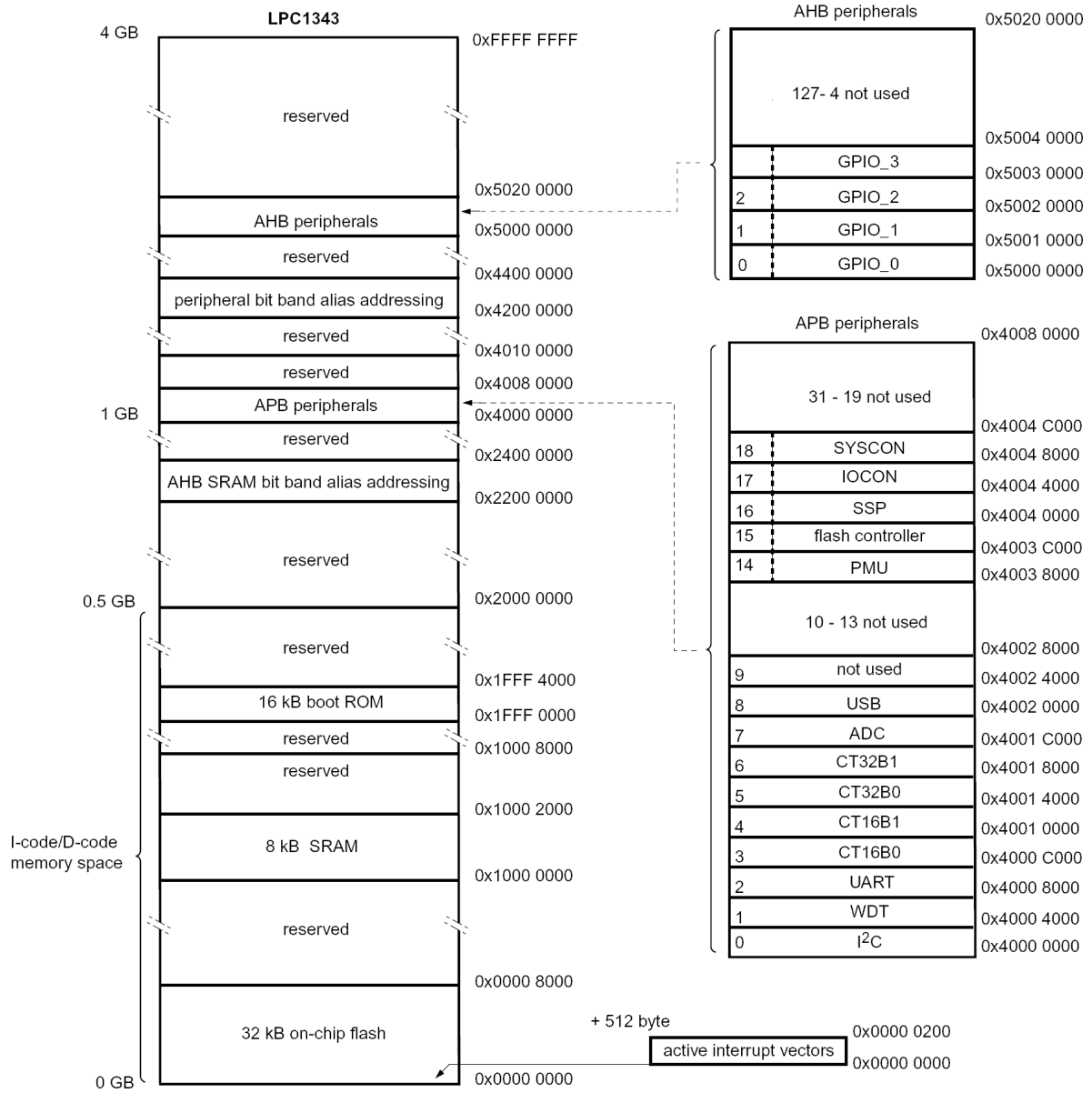

BOARD LAYOUT

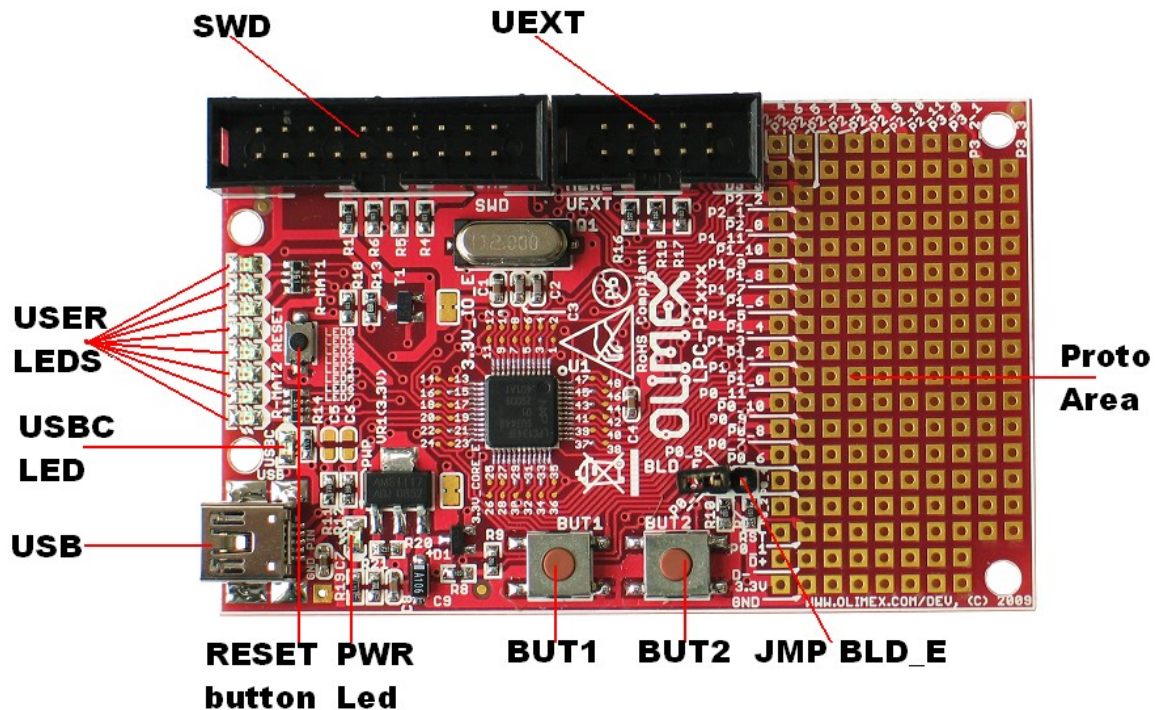

POWER SUPPLY CIRCUIT

LPC-P1343 is power supplied +5V via USB, or via JTAG.

RESET CIRCUIT

LPC-P1343 reset circuit includes LPC1343 pin 3 (#RESET/PIO0_0), R18 (10k) and RESET button.

CLOCK CIRCUIT

Quartz crystal 12 MHz is connected to LPC1343 pin 6 (XTALIN) and pin 7 (XTALOUT).

JUMPER DESCRIPTION

3.3V_CORE_E



This jumper, when closed, enables microcontroller 3.3V power supply.
Default state is closed.

3.3V(I/O)_E



This jumper, when closed, supplies 3.3 V voltage to LPC1343 pin 8 (VDDIO).
Default state is closed.

BLD_E



If BLD_E is closed during Reset and USB is connected to computer, then removable disk will appear in My computer. The user can create via IAR ".bin" file, which can be placed into the removable disk. After this when you open jumper BLD_E and then reset the board the microcontroller will execute the program stored in the ".bin" file. Default state is open.

INPUT/OUTPUT

LED0 (red) connected via R-MAT1 to LPC1343 pin 36 (PIO3_0).

LED1 (red) connected via R-MAT1 to LPC1343 pin 37 (PIO3_1).

LED2 (red) connected via R-MAT1 to LPC1343 pin 43 (PIO3_2).

LED3 (red) connected via R-MAT1 to LPC1343 pin 48 (PIO3_3).

LED4 (red) connected via R-MAT2 to LPC1343 pin 18 (PIO2_4).

LED5 (red) connected via R-MAT2 to LPC1343 pin 21 (PIO2_5).

LED6 (red) connected via R-MAT2 to LPC1343 pin 1 (PIO2_6).

LED7 (red) connected via R-MAT2 to LPC1343 pin 11 (PIO2_7).

USBC (yellow) shows that USB is connected.

Power-on LED (red) - this LED shows that +3.3V is applied to the board.

User button with name **BUT1** (USER) connected to **LPC1343** pin 24 (PIO2_9).

User button with name **BUT2** connected to **LPC1343** pin 40 (WAKEUP).

Reset button with name **RESET** connected to **LPC1343** pin 3 (#RESET/PIO0_0).

EXTERNAL CONNECTORS DESCRIPTION

UEXT

Pin #	Signal Name
1	3.3V
2	GND
3	TXD
4	RXD
5	SCL
6	SDA
7	MISO
8	MOSI/SWV
9	SCK
10	CS

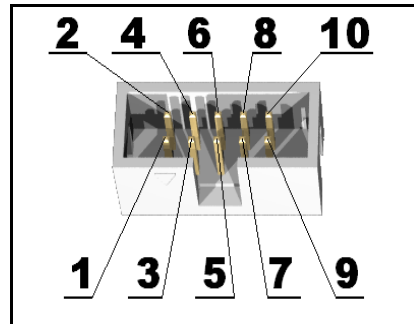

SWD

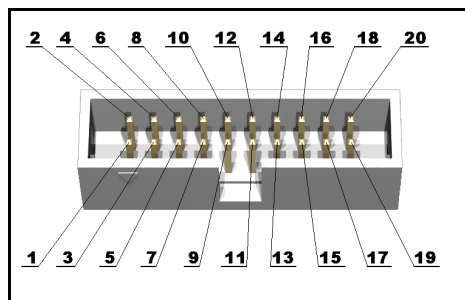

Pin #	Signal Name	Pin #	Signal Name
1	3.3V	2	3.3V
3	NC	4	GND
5	NC	6	GND
7	SWD	8	GND
9	SWC	10	GND
11	pull-down	12	GND
13	MOSI/SWV	14	GND
15	NC	16	GND
17	pull-down	18	GND
19	+5V_JLINK	20	GND

USB

Pin #	Signal Name
1	USB_VBUS
2	U2D-
3	U2D+
4	NC
5	GND

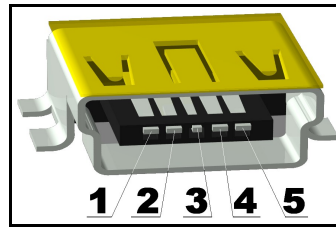

MECHANICAL DIMENSIONS

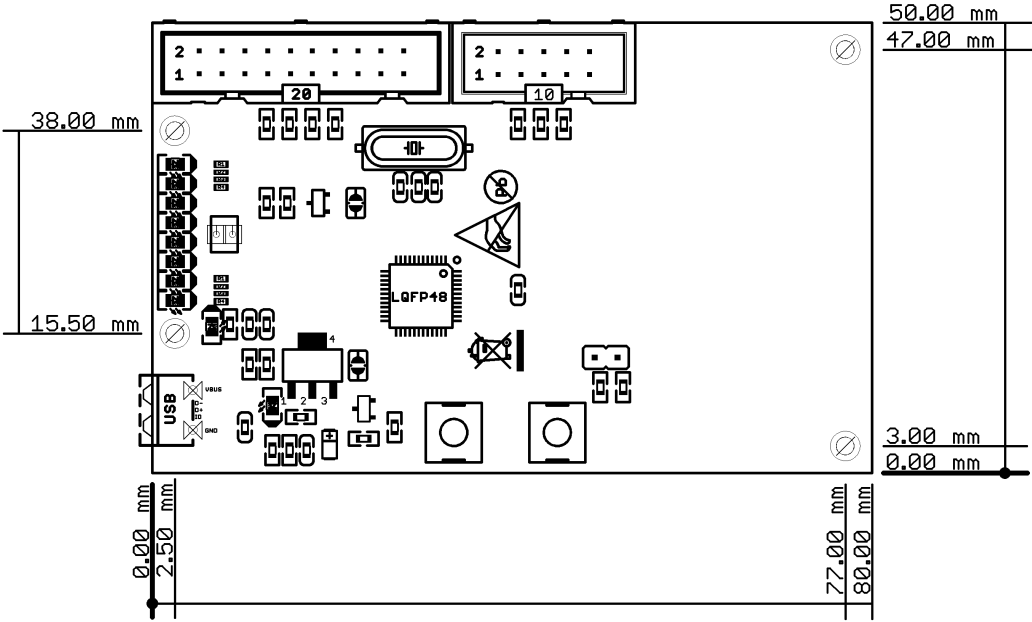

AVAILABLE DEMO SOFTWARE

- [LPC1343 demo examples](#) project for EW-ARM

ORDER CODE

LPC-P1343 - assembled and tested board

How to order?

You can order directly from our web shop or by any of our distributors. The list of distributors may be found here:

<https://www.olimex.com/Distributors/>

Check our web site <https://www.olimex.com/> for more info.

Revision history

Revision Initial, December 2009

Revision A, February 2011 - available demo software added

Revision B, May 2012 - fixed errors on page 9 regarding LED4 and LED5 processor pins

Revision C, February 2013 - updated links, disclaimer and suggested debuggers

DISCLAIMER

© 2013 Olimex Ltd. Olimex®, logo and combinations thereof, are registered trademarks of Olimex Ltd. Other product names may be trademarks of others and the rights belong to their respective owners.

The information in this document is provided in connection with Olimex products. No license, express or implied or otherwise, to any intellectual property right is granted by this document or in connection with the sale of Olimex products.

The Hardware project is released under the Creative Commons Attribution-Share Alike 3.0 United States License. You may reproduce it for both your own personal use, and for commercial use. You will have to provide a link to the original creator of the project <https://www.olimex.com> on any documentation or website.

You may also modify the files, but you must then release them as well under the same terms. Credit can be attributed through a link to the creator website: <https://www.olimex.com>.

The software is released under GPL.

It is possible that the pictures in this manual differ from the latest revision of the board.

The product described in this document is subject to continuous development and improvements. All particulars of the product and its use contained in this document are given by OLIMEX in good faith. However all warranties implied or expressed including but not limited to implied warranties of merchantability or fitness for purpose are excluded. This document is intended only to assist the reader in the use of the product. OLIMEX Ltd. shall not be liable for any loss or damage arising from the use of any information in this document or any error or omission in such information or any incorrect use of the product.

This product is intended for use for engineering development, demonstration, or evaluation purposes only and is not considered by OLIMEX to be a finished end-product fit for general consumer use. Persons handling the product must have electronics training and observe good engineering practice standards. As such, the goods being provided are not intended to be complete in terms of required design-, marketing-, and/or manufacturing-related protective considerations, including product safety and environmental measures typically found in end products that incorporate such semiconductor components or circuit boards.

Olimex currently deals with a variety of customers for products, and therefore our arrangement with the user is not exclusive. Olimex assumes no liability for applications assistance, customer product design, software performance, or infringement of patents or services described herein.

THERE IS NO WARRANTY FOR THE DESIGN MATERIALS AND THE COMPONENTS USED TO CREATE LPC-P1343. THEY ARE CONSIDERED SUITABLE ONLY FOR LPC-P1343.