

Features

- In-plane linear accelerometer
- ± 15 g range
- Superior non-linearity of 100 ppm thanks to the closed-loop operation
- Excellent bias instability of 3 μ g
- 24 bit output with digital SPI interface
- Ultra low noise
- Embedded temperature sensor for on-chip or external temperature compensation
- Built-in Self-Test
- 12x12mm hermetic J-Lead ceramic package
- Weight : 1.4 grams
- Full compatibility with GYPRO® products
- REACH and RoHS compliant

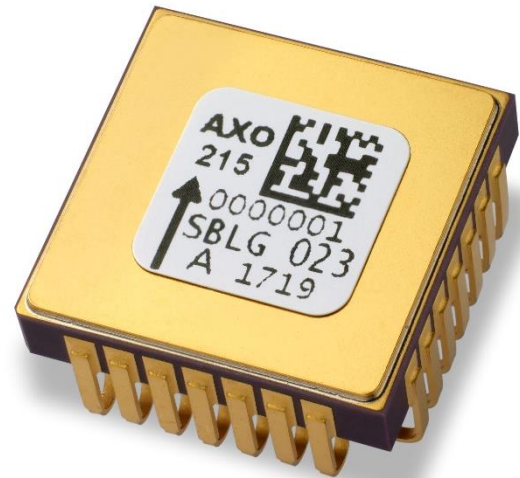

General Description

AXO215 sensors consist in a MEMS transducer and an integrated circuit (IC) packaged in a 28-pins J-leaded Ceramic Package.

AXO® product is ideally complementing the industry-standard GYPRO® product line.

The MEMS transducer is manufactured using Tronics' wafer-level packaging technology based on micro-machined thick single crystal silicon.

When the sensor is subjected to a linear acceleration, the acceleration acts on the proof-mass, which is itself counterbalanced by electrostatic forces (closed-loop operation).

The sensor is factory calibrated and compensated for temperature effects to provide high-accuracy digital output over a broad temperature range.

Raw data output can be also chosen to enable customer-made compensations.

Disclaimer

Information furnished by Tronics is believed to be accurate and reliable. However, no responsibility is assumed by Tronics for its use, nor for any infringements of patents or other rights of third parties that may result from its use.

Specification subject to change without notice.

No license is granted by implication or otherwise under any patent or patent rights of Tronics. Trademarks and registered trademarks are the property of their respective owners.

Table of Contents

Features	1
General Description	1
Table of Contents	1
Disclaimer.....	1
Block diagram.....	2
Overall Dimensions	2
1. Specifications	3
2. Maximum Ratings	5
3. Typical performances	6
4. Interface	8
4.1. Pinout, Sensitive Axis identification.....	8
4.2. Application circuit.....	8
4.3. Input/Output Pin Definitions	9
5. Soldering Recommendations	10
6. Digital SPI interface	11
6.1. Electrical and Timing Characteristics	11
6.2. SPI frames description	12
6.3. Acceleration readings	12
6.4. Temperature readings	12
6.5. Advanced use of SPI registers.....	13
7. Temperature Sensor Calibration Procedure	15
7.1. Temperature sensor calibration model	15
7.2. Recommended Procedure	15
8. Device Identification	15
9. Internal construction and Theory of Operation	16
10. Available Tools and Resources	17

AXO215 Datasheet MCD006-C

Block diagram

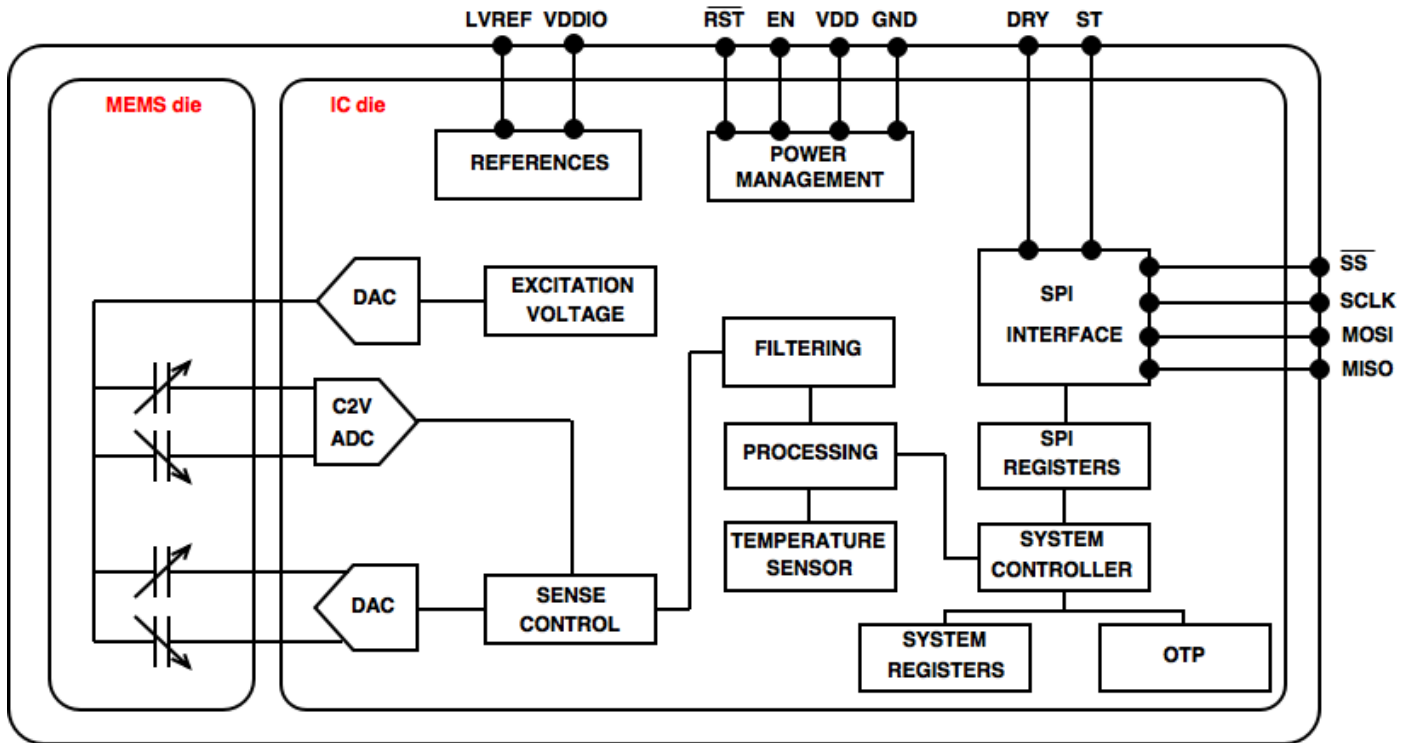

Overall Dimensions

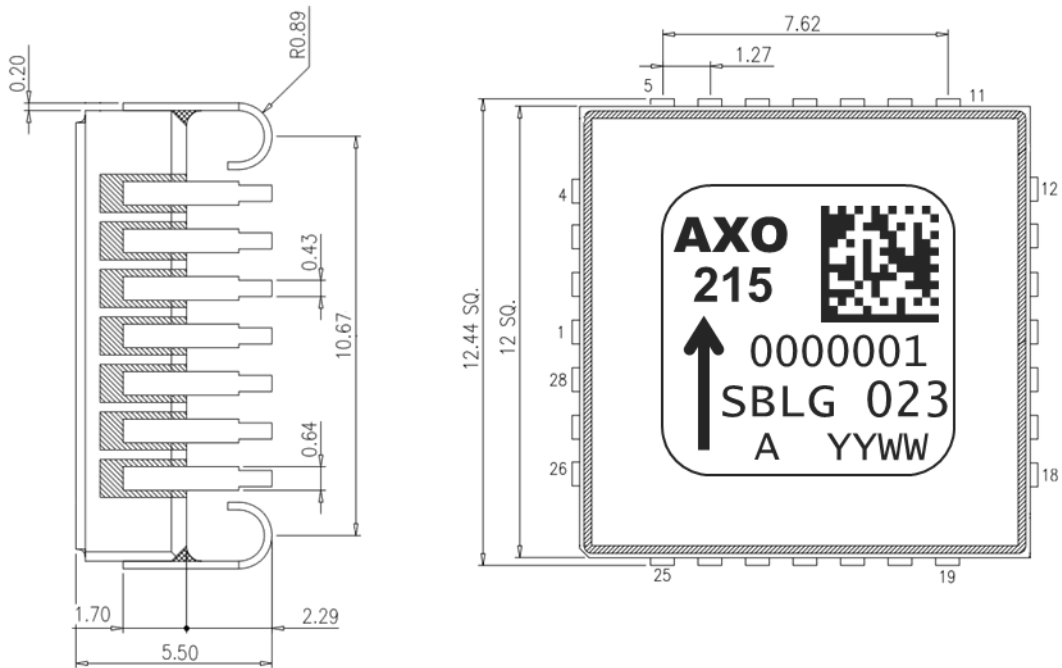

1. Specifications

MIN and MAX values are identified by '<' or '>' symbols. For instance: ± 5 means "parameter value is within -5 and +5". <100 means "parameter value is within 0 and 100".

TYPICAL values are indicated without '<' or '>' symbols.

Parameter	Unit	Values	Notes
Measurement Ranges			
Full Scale range	g	± 15	
Temperature range *	°C	-40 to +85	
Bias			
Bias instability	μg	3	Lowest point of Allan variance curve @room temperature
Bias in-run (short term) stability	μg	10 (<100)	Standard deviation of 1 second filtered output over 1 hour at room temperature, after 30 min of stabilization
Bias temperature variations, calibrated *	mg	$<\pm 5$	Over temperature range
Bias repeatability	mg	$<\pm 2$	Including on/off switch and day-to-day variations
Bias long term stability	mg	1	Drift per year
Vibration rectification error	$\mu\text{g}/\text{g}^2$	<100	Bias rectification under operating vibrations; quadratic average of each axis contribution.
Scale Factor			
Scale Factor *	LSB/g	500 000	
Scale Factor temperature variations, calibrated *	ppm	$<\pm 1500$	Over temperature range
Scale Factor repeatability	ppm	$<\pm 1000$	Including on/off switch and day-to-day variations
Scale Factor long term stability	ppm	500	Drift per year
Linearity, Noise			
Non linearity *	ppm	100 (<500)	Maximum deviation from best fit straight line over the [0g ; 8g] range, at room temperature
Noise density *	$\mu\text{g}/\sqrt{\text{Hz}}$	15 (<20)	Over the [0 - 300] Hz frequency range, at room temperature
Frequency response			
Bandwidth	Hz	>300	Defined as the frequency for which attenuation is $>-3\text{dB}$
Data Rate	Hz	≥ 1700	Refresh rate of the output data at room temperature
Latency	ms	<1	Time delay between the physical acceleration (input) and the output signal
Start-up Time	ms	500	Time interval between the application of power and the presence of a usable output, i.e. at least 90% of the input, at room temperature

Parameter	Unit	Values	Notes
Axis alignment			
Axis misalignment	mrad	<20	
Environmental			
Storage temperature range	°C	-55 to +100	
Component shelf life	Years	5	
Humidity at 45°C	%	<98	
Moisture Sensitivity Level (MSL)	--	1	Unlimited (hermetic package)
Shock (operating)	g ms	50 6	Half sine
Shock (survival)	g ms	2000 0.3	
Vibrations (operating)	g _{rms}	4.12	DO-160G standard , curve C
Vibrations (survival)	g _{rms}	20	Random acceleration, applied on any axis within 20Hz to 2kHz during 10min
Electrical			
Power Supply Voltage	V	4.75 to 5.25	
Current consumption (normal mode) *	mA	25	
Current consumption (power down mode) *	µA	<5	Power down mode is activated by switching EN pin to GND, at room temperature
Power supply rejection ratio	µg/V	100	
Temperature sensor			
Scale Factor (raw data)	LSB/°C	85	Temperature sensor is not factory-calibrated.
25°C typical output (raw data)	LSB	8 000	Temperature sensor is not factory-calibrated.
Refresh rate	Hz	6	

Table 1: Specifications

* 100% tested in production.

2. Maximum Ratings

Stresses higher than the maximum ratings listed below may cause permanent damage to the device, or affect its reliability. Functional operation is not guaranteed after stresses higher than the maximum ratings have been applied.

Exposure to maximum ratings conditions for extended periods may affect device reliability.

Parameter	Unit	Min	Max
Supply Voltage	V	-0.5	+7
Electrostatic Discharge (ESD) protection, any pin, Human Body Model	kV	--	±2
Storage temperature range	°C	-55	+100
Shock survival, half sine	g	--	2000
Vibrations survival, 20-2000Hz	g _{rms}	--	20
Ultrasonic cleaning		Not allowed	

Table 2: Maximum ratings

Caution!



The product may be damaged by ESD, which can cause performance degradation or device failure! We recommend handling the device only on a static safe work station. Precaution for the storage should also be taken.



The sensor **MUST** be powered-on *before* any SPI operation. Having the SPI pads, VDDIO or EN at a high level while VDD is at a low level could damage the sensor, due to ESD protection diodes and buffers.

3. Typical performances

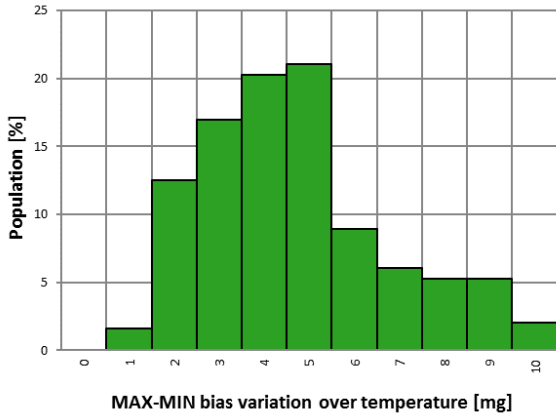

Figure 1: Bias distribution over temperature

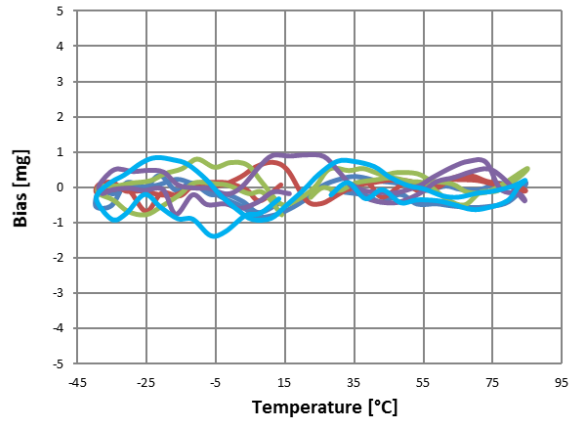

Figure 4: Bias variations over Temperature (5 samples)

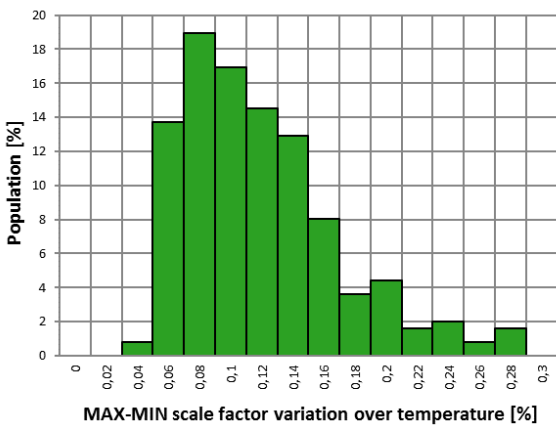

Figure 2: Scale Factor distribution over temperature

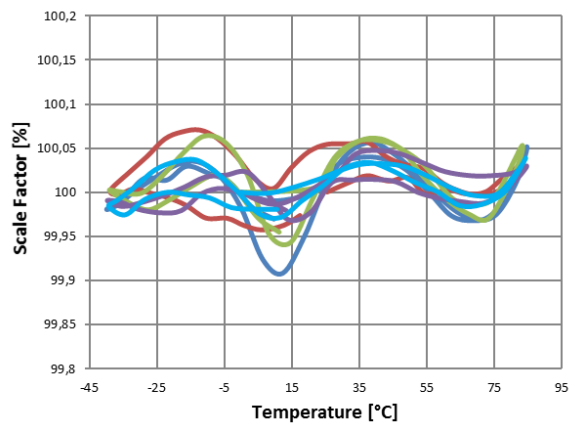

Figure 5: Scale Factor variations over Temperature (5 samples)

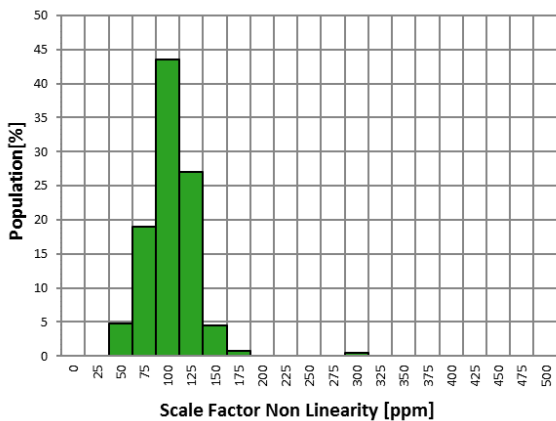

Figure 3: Scale Factor non linearity distribution (25°C)

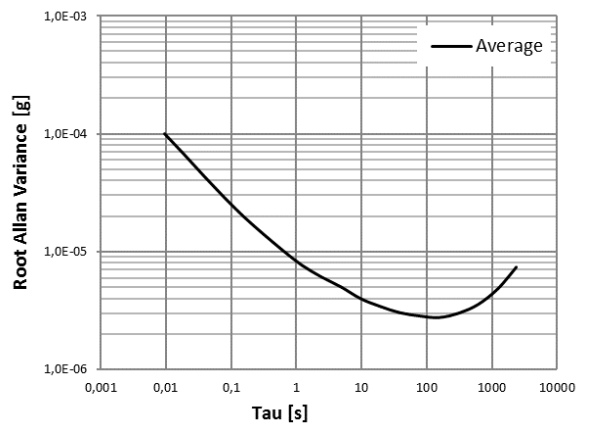

Figure 6: Allan variance (room temperature)

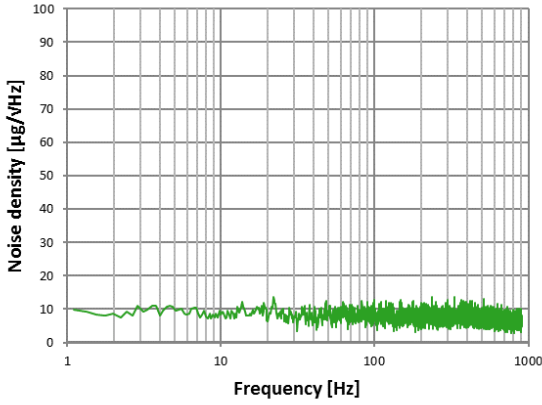

Figure 7: Typical noise density (room temperature)

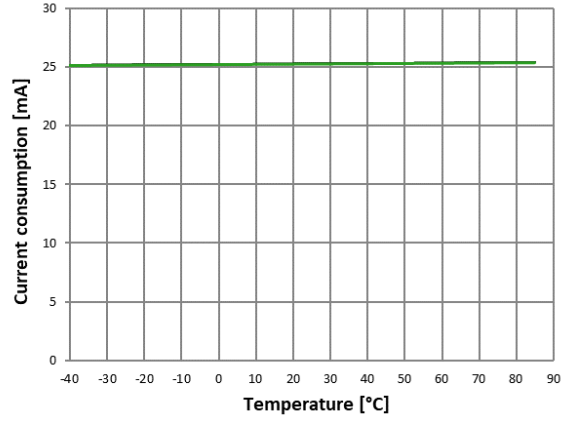

Figure 10: Typical current consumption temperature variations

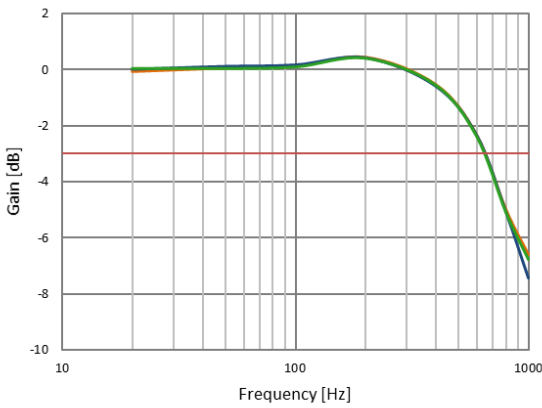

Figure 8: Frequency response (3 samples at RT)

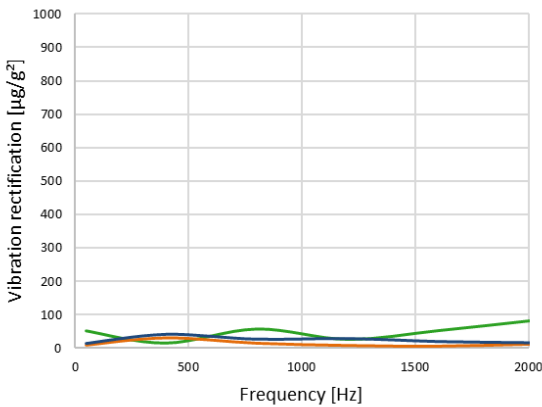

Figure 9: Vibration rectification error (3 samples, quadratic average on sensitive axis and 2 transverse axes)

AXO215 Datasheet MCD006-C

4. Interface

4.1. Pinout, Sensitive Axis identification

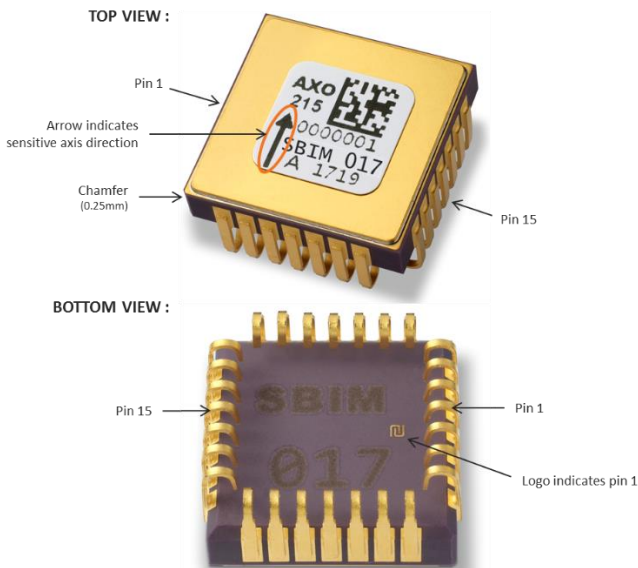

Figure 11: How to locate Pin 1 and Sensitive Axis

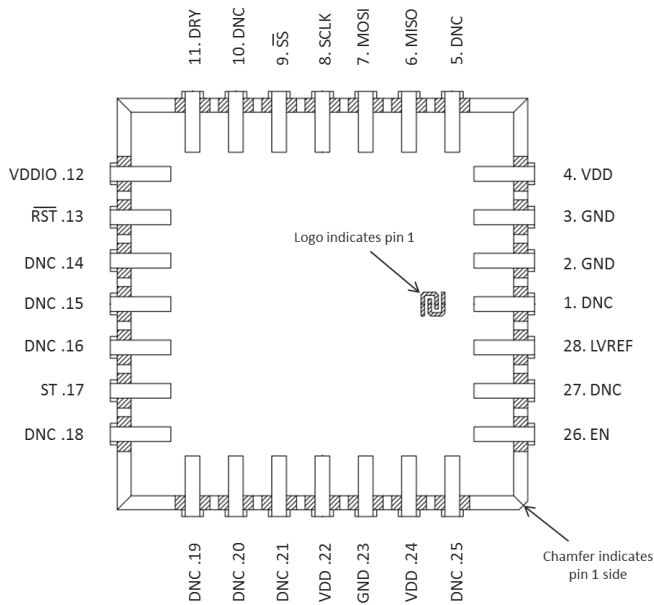

Figure 12: AXO215 Sensors Pinout (BOTTOM VIEW)

4.2. Application circuit

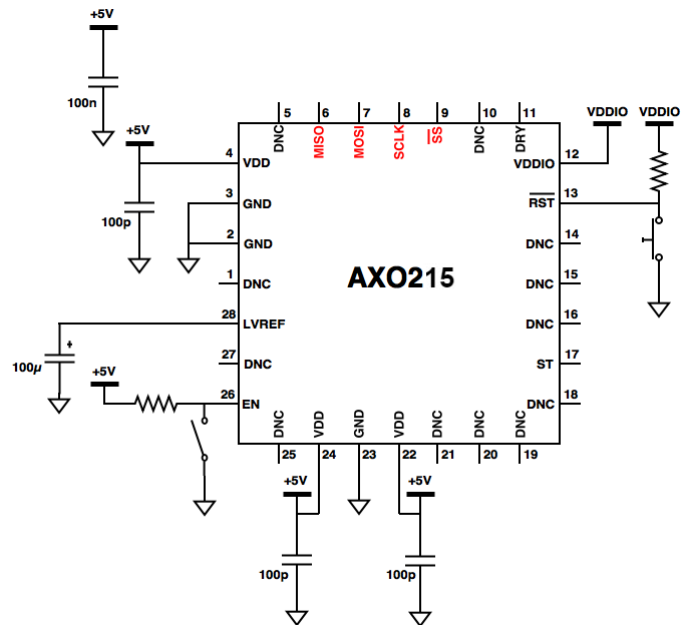

Figure 13: Recommended Application Schematic

Notes:

- All capacitances of Figure 13 should be placed as close as possible to their corresponding pins, except the 100nF capacitance between VDD and GND, which should be as close as possible to the board's supply input.
- The 100µF filtering capacitance between LVREF and GND should have low Equivalent Series Resistance (ESR < 1Ω) and low leakage current (< 6µA).

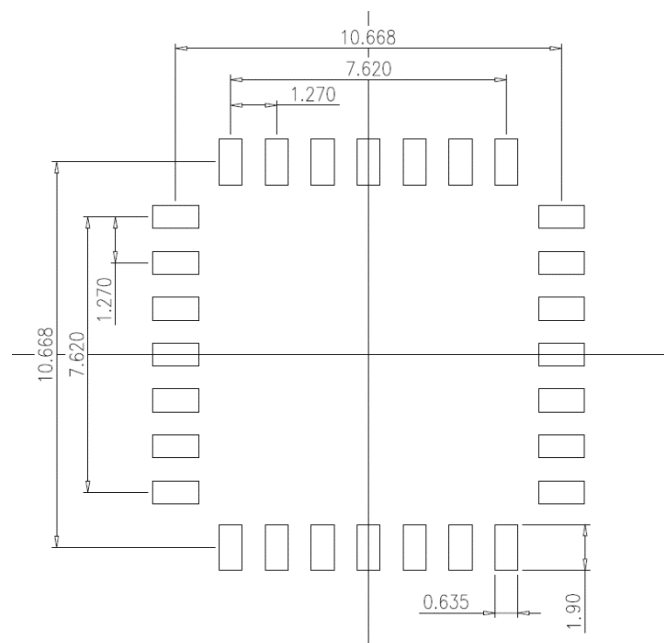

Figure 14: Recommended Pad Layout (dimensions in mm)

4.3. Input/Output Pin Definitions

Pin name	Pin number	Pin type	Pin direction	Pin levels	Function
GND	2, 3, 23	Supply	n/a	0V	Power Ground
VDD	4, 22, 24	Supply	n/a	+5V	Power Supply
MISO	6	Digital	Input	VDDIO	Master Input Slave Output signal
MOSI	7	Digital	Output	VDDIO	Master Output Slave Input signal
SCLK	8	Digital	Input	VDDIO	SPI clock signal
\overline{SS}	9	Digital	Input	VDDIO	Slave Selection signal. Active low
DRY	11	Digital	Output	VDDIO	Data Ready flag. Generates a pulse when a new acceleration data is available.
VDDIO	12	Supply	n/a	+1.8V to +5V	Reference voltage for the SPI signals and DRY, RSTB wires.
\overline{RST}	13	Digital	Input	VDDIO with pull-up of 100k Ω	Reset. Reloads the internal calibration data.
ST	17	Digital	Output	+5V	Self-test status. Logic "1" when the sensor is OK \Leftrightarrow initial self-test of the numeric blocks has been passed, and the sense loop is closed.
EN	26	Digital	Input	+5V	Enable command. Active high.
LVREF	28	Analog	n/a	4.4V	External decoupling pad. MUST be connected to the board's VSS through a 100 μ F external capacitor, in order to ensure low noise.
DNC	1, 5, 10, 14, 15, 16, 18, 19, 20, 21, 25 & 27	--	--	--	Do Not electrically Connect. These pins provide additional mechanical fixing to the Host System and should be soldered to an unconnected pad.

Table 3: Pin Functions

Note: The digital pads maximum ratings are GND-0.3V and VDD+0.3V.

5. Soldering Recommendations

Please note that the reflow profile to be used does not depend only on the sensor. The whole populated board characteristics shall be taken into account.

IMPORTANT NOTES: The package leads are gold-plated. To obtain a reliable soldering, it is recommended to eliminate the excess gold, by performing a pre-tinning step.

If you are using flux cleaner after soldering, please avoid spreading the sticker, so that it stays readable.

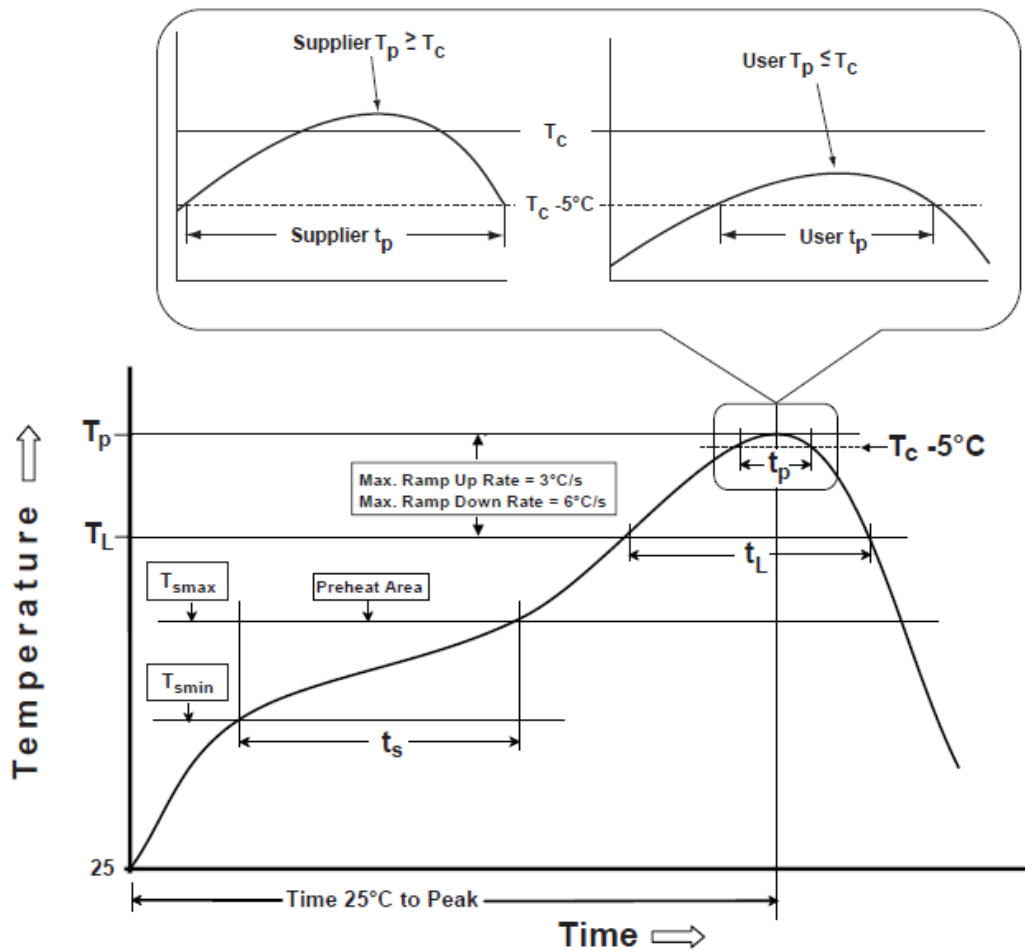

Figure 15: Reflow Profile, according to IPC/JEDEC J-STD-020D.1

Profile Feature	Sn-Pb Eutectic Assembly	Pb-Free Assembly
Time maintained above		
Temperature (T_L)	183°C	217°C
Time (t_L)	60-150 sec	60-150 sec
Peak Temperature (T_p)	240°C (+/-5°C)	260°C (+/-5°C)
Time within 5°C of Actual Peak Temperature (t_p)	10-30 sec	10-40 sec

Table 4: Reflow Profile Details, according to IPC/JEDEC J-STD-020D.1

6. Digital SPI interface

6.1. Electrical and Timing Characteristics

The device acts as a slave supporting only SPI “mode 0” (clock polarity CPOL=0, clock phase CPHA=0).

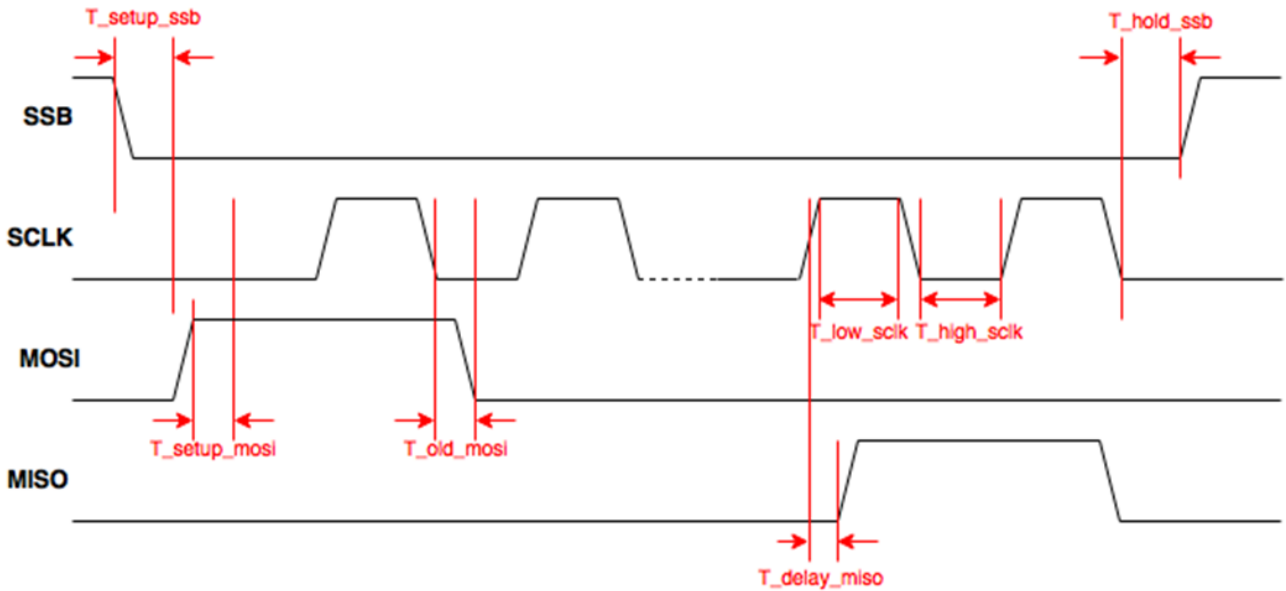

Figure 16: SPI timing diagram

Symbol	Parameter	Condition	Unit	Min	Typ	Max
Electrical characteristics						
VIL	Low level input voltage		VDDIO	0		0.1
VIH	High level input voltage		VDDIO	0.8		1
VOL	Low level output voltage	ioL=0mA (Capacitive Load)	V		GND	
VOH	High level output voltage	ioH=0mA (Capacitive Load)	V		VDDIO	
Rpull_up	Pull-up resistor	Internal pull-up resistance to VDD	kΩ		100	
Rpull_down	Pull-down resistor	Internal pull-down resistance to GND	kΩ		-	
Timing parameters						
Fspi	SPI clock input frequency	Maximal load 25pF on MOSI or MISO	MHz		0.2	8
T_low_sclk	SCLK low pulse		ns	62.5		
T_high-sclk	SCLK high pulse		ns	62.5		
T_setup_din	MOSI setup time		ns	10		
T_hold_din	MOSI hold time		ns	5		
T_delay_dout	MISO output delay	Load 25pF	ns			40
T_setup_csb	SS setup time		Tsclk	1		
T_hold_csb	SS hold time		Tsclk	1		

Table 5: SPI timing parameters

The MISO pin is kept in high impedance when the SSB level is high, which allows sharing the SPI bus with other components.

IMPORTANT NOTE: It is forbidden to keep SPI pads at a high level while VDD is at 0V due to ESD protection diodes and buffers.

6.2. SPI frames description

The SPI frames used for the communication through the SPI Register are composed of an instruction followed by arguments. The SPI instruction is composed of 1 byte, and the arguments are composed of 2, 4 or 8 bytes, depending on the cases, as can be seen in Table 6 below.

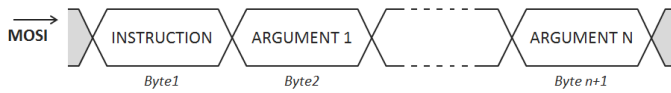

Figure 17: SPI Message Structure

Instruction	Argument	Meaning
0x50	0x00000000 (n=4)	Read Acceleration
0x54	0x0000 (n=2)	Read Temperature
0x58	0x00000000 (n=4)	Advanced commands. See Section 6.5 for more details.
0x78	0XXXXXXXX (n=8)	
0x7C	0XXXXX (n=2)	

Table 6: Authorized SPI commands

6.3. Acceleration readings

From the 32-bits (4 bytes) frame obtained after the “Read acceleration” command, the 24-bits word of acceleration data (ACC) must be extracted as shown below in Figure 18.

DRY and ST are respectively the “data ready” and “self-test” bits, also directly available on Pins 11 and 17 of the sensor.

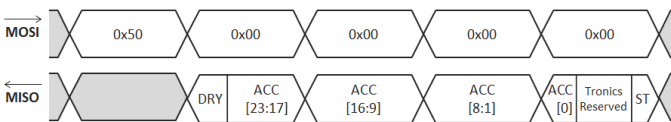

Figure 18: Acceleration reading frames and data organization

6.3.1. Acceleration (ACC) output

The 24-bit accelerometer output is coded in two's complement (Table 7).

- If the temperature compensation is not enabled (A_COMP_ON=0), then the user should perform scale factor measurements.
- If the temperature compensation of the acceleration output is enabled (default case),

dividing the 24-bit value by a factor **500 000** results in the acceleration in g, as shown in Table 7.

-15.0000	g	⇔	1000 1101 1000 1111 0010 1111
			..
-0.000004	g	⇔	1111 1111 1111 1111 1111 1110
-0.000002	g	⇔	1111 1111 1111 1111 1111 1111
0.000000	g	⇔	0000 0000 0000 0000 0000 0000
+0.000002	g	⇔	0000 0000 0000 0000 0000 0001
+0.000004	g	⇔	0000 0000 0000 0000 0000 0010
			..
+15.0000	g	⇔	0111 0010 0111 0000 1110 0000

Table 7: Conversion table for calibrated acceleration output

6.3.2. Data Ready (DRY) bit

The Data Ready bit is a flag which is raised when a new acceleration data is available. The flag stays raised until the data is read.

Similarly to the Data Ready pin, the Data Ready bit signal can be used as an interrupt signal to optimize the delays between newly available data and their readings.

6.3.3. Self-Test (ST) bit

The ST bit contains same information as the ST pin.

It raises a flag (1 logic) at the same frequency as the accelerometer data rate, indicating if the sensor is properly operating (i.e. the MEMS mobile mass is at its equilibrium position, and the closed loop is in normal mode).

The self-test procedure is running in parallel with the main functions of the sensor.

The ST pin can be connected to an interrupt input.

6.4. Temperature readings

The temperature data is an unsigned integer, 14-bits word (TEMP). It must be extracted from the 2 bytes of read data, as shown below in Figure 19.

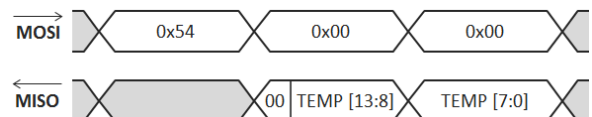

Figure 19: Temperature reading frames and data organization

By default the temperature sensor is *not* factory-calibrated (T_CAL_ON=0).

6.5. Advanced use of SPI registers

SPI registers can also be used to access the System register or the MTP (Multi-Time-Programmable memory).

6.5.1. R/W access to the System Registers

IMPORTANT NOTE: Modifications to the system registers are **reversible**. Modified registers will *not* be restored after a RESET. There is no limitation to the number of times the system registers can be modified.

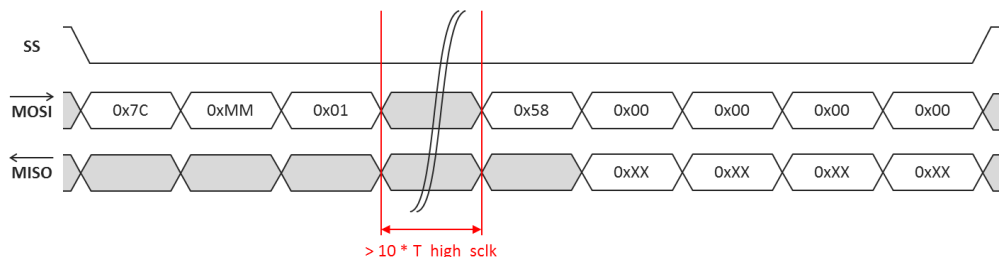

Figure 20: Sequence of instructions to READ address MM of the system registers

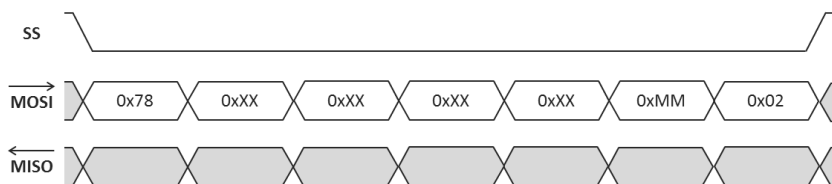

Figure 21: Sequence of instructions to WRITE '0XXXXXXXX' to address '0xMM' of the system registers

6.5.2. R/W access to the MTP

IMPORTANT NOTE: Modifications to the MTP are **non-reversible**. Modified parameters will be restored, even after a RESET, and previous values of the MTP cannot be accessed anymore. The maximum number of times the MTP can be written depends on the address:

- 5 times for the acceleration calibration coefficients (not described in this document; please contact Tronic if you need more information about this topic)
- Only 1 time for all the other coefficients, including the temperature sensor calibration coefficients.

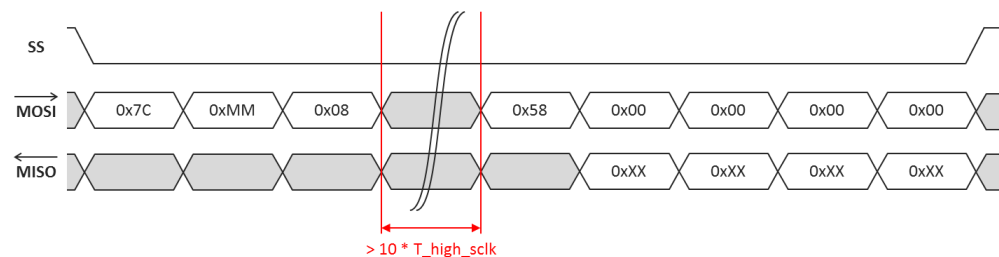

Figure 22 : Sequence of instructions to READ address 0xMM of the MTP

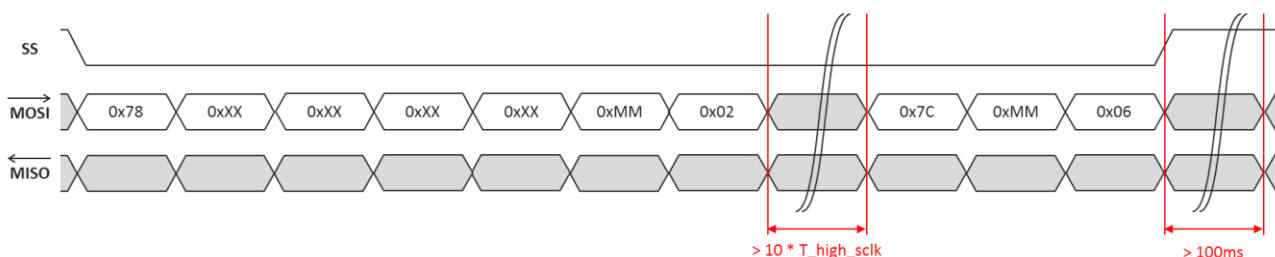

Figure 23: Sequence of instructions to WRITE data '0XXXXXXXX' to address '0xMM' of the MTP

6.5.3. Useful Sensor Parameters

The instructions given in Sections 6.5.1 and 6.5.2 can be used to read and/or to modify the sensor's useful parameters given in Table 8 below.

Parameter	Address M (System Register & MTP)	Bits	Encoding	Meaning
UID	0x03	[31:1]	Decimal	Sensor 'Unique Identification' number
A_COMP_ON	0x3D	31 *	0 1 **	Disable the calibrated acceleration output Enable the calibrated acceleration output
T_CAL_ON	0x04	3 *	0 ** 1	Disable the calibrated temperature output Enable the calibrated temperature output
O	0x04	[31:18] *	0x0000 ** See § 7	Offset calibration of temperature sensor
G	0x04	[17:4] *	0x0800 ** See § 7	Gain calibration of temperature sensor

Table 8: Useful parameters information

Notes:

* The other bits at those addresses shall remain unchanged. Please make sure that you write them with no modification!

** Default Value

7. Temperature Sensor Calibration Procedure

The temperature output of AXO215 sensors is *not* factory-calibrated, since only the raw temperature information is needed by the acceleration calibration blocks. However, it is possible to perform a first-order polynomial calibration of the temperature sensor, in order to output the absolute temperature information.

This section shows how to get and store temperature calibration parameters for the temperature output.

7.1. Temperature sensor calibration model

The formula below models the link between raw and calibrated acceleration outputs:

$$T[^{\circ}\text{C}] = \frac{T_{\text{COMP_OUT}}[\text{LSB}]}{\text{GAIN}_{\text{setting}}[\text{LSB}/^{\circ}\text{C}]} = \frac{\text{GAIN} \cdot T_{\text{RAW}}[\text{LSB}] - \text{OFFSET}[\text{LSB}]}{\text{GAIN}_{\text{setting}}[\text{LSB}/^{\circ}\text{C}]}$$

where:

- T is the output temperature converted in °C;
- T_{COMP_OUT} is the calibrated temperature output;
- GAIN_{setting} is the constant conversion factor from LSB to °C for the calibrated temperature output. This gain is set to 20LSB/°C to provide an output resolution of 0,1°C;
- T_{RAW} is the raw data temperature output;
- **OFFSET** is a constant coefficient to tune the offset;
- **GAIN** is a constant coefficient to tune gain.

The **OFFSET** and **GAIN** parameters will be obtained and written in the IC through the following calibration procedure.

7.2. Recommended Procedure

1. Check that T_CAL_ON = 0. If not, set it to 0 in the System Registers.
2. Measure the temperature output with at least 2 temperature points

3. Calculate the GAIN and OFFSET coefficients according to formula above

$$\text{GAIN} = \text{GAIN}_{\text{setting}} \cdot \frac{T1_{\text{ABS}}[^{\circ}\text{C}] - T2_{\text{ABS}}[^{\circ}\text{C}]}{T1_{\text{RAW}}[\text{LSB}] - T2_{\text{RAW}}[\text{LSB}]}$$

$$\text{OFFSET} = \text{GAIN}_{\text{setting}} \cdot T1_{\text{ABS}}[^{\circ}\text{C}] - \text{GAIN} \cdot T1_{\text{RAW}}[\text{LSB}]$$

where:

- T1_{ABS} is the absolute temperature of T₁ in °C;
 - T2_{ABS} is the absolute temperature of T₂ in °C;
 - T1_{RAW} is the raw output temperature of T₁ in LSB;
 - T2_{RAW} is the raw output temperature of T₂ in LSB;
4. Convert GAIN and OFFSET to their binary values according to Table 9 below:

Parameter	Value (decimal)	Format
G	GAIN . 2 ¹¹	Unsigned
O	OFFSET	Unsigned

Table 9: Temperature calibration parameters

5. [Optional step: Write GAIN and OFFSET in the System Registers and repeat step 2. to check for the new calibration accuracy.]
6. Write GAIN and OFFSET in the MTP according to instructions of Section 6.5.2. Meanwhile, set T_CAL_ON to 1 during this step, so that the new calibration parameters are effective after a RESET.

8. Device Identification

AXO215 tracking information is accessible on the label, as shown in the next figure.



Figure 24: AXO215 label.

9. Internal construction and Theory of Operation

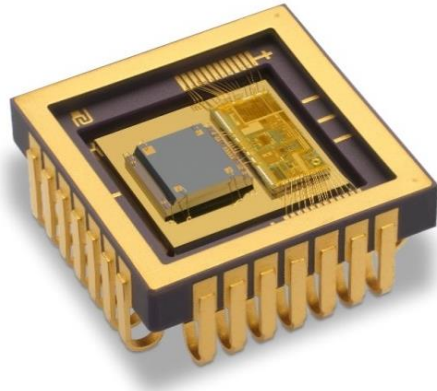

Figure 25 : Inner view of the package, showing the MEMS and IC

AXO215 sensor is using the dominant architecture for high performance MEMS accelerometers, namely the “In-plane Force-rebalance” design. A symmetric silicon proof mass is suspended by pairs of opposing spring flexures on either side of the proof mass. An applied acceleration acts on the proof mass. This in-plane motion is counterbalanced by applying voltages that generate electrostatic forces to rebalance the proof mass (closed-loop operation). The applied voltage is directly proportional to the input acceleration.

In details, each sensor consists in a MEMS transducer and an integrated circuit (IC) packaged in a 28-pins J-leaded Ceramic Package.

The MEMS transducer is manufactured using Tronics’ wafer-level packaging technology based on micro-machined thick single crystal silicon.

When the sensor is subjected to a linear acceleration, the acceleration acts on the proof-mass, which is itself counterbalanced by electrostatic forces (closed-loop operation).

The sensor is factory calibrated and compensated for temperature effects to provide high-accuracy digital output over a broad temperature range.

Raw data output can be also chosen to enable customer-made compensations.

The MEMS die is located on the left part of the block diagram. Differential detection and actuation are used for efficient common mode rejection.

The IC is located on the right part of the block diagram. The IC is designed to interface the MEMS sensing element. It includes ultra-low noise capacitive to voltage converters (C2V) followed by high resolution voltage digitization (ADC). Excitation voltage required for capacitance sensing circuits is generated on the common electrode node. 1-bit force feedbacks (DAC) are used for electrostatic actuation.

The choice for the implemented closed-loop architecture based on a Sigma-Delta principle is particularly well adapted as it brings the following key advantages:

- 1) Sigma-Delta is well suited for low-frequency signals. Noise shaping principle rejects quantization noise in high frequency bands.
- 2) Simplicity of hardware implementation. Oversampling concept allows significant design relaxation of the analog detection chain signal resolution. Additionally the voltage reference used for actuation force feedback is also of simple implementation as it is a 1-bit D/A converter, thus simplifying its design.
- 3) Linearization of the electrostatic forces thanks to the Sigma-delta principle (through force averaging) furthermore reduces non-linearity overall and more importantly its even-order terms, which result in rectification error.
- 4) Sigma-Delta signal output is inherently a digital signal, thus suppressing the need for costly high resolution A/D converter.

The digital part implements digital control loop and processes the acceleration output based on the on-chip temperature sensor output. The system controller manages the interface between the SPI registers, the system register and the non-volatile memory (OTP). The non-volatile memory provides the accelerometer settings, in particular the coefficients for acceleration temperature compensation. On power up, the settings are transferred from the OTP to the system registers and output data are available in the SPI registers. The acceleration output and the temperature sensor output are available in the SPI registers. The SPI registers are available through the SPI interface (SS, SCK, MOSI, MISO). The self-test and the data ready are available respectively on the external pin ST and DRY.











The “References” block generates the required biasing currents and voltages for all blocks as well as the low-noise reference voltage for critical blocks.

The “Power Management” block manages the power supply of the sensor from a single 5V supply between the VDD and GND pins. It includes a power on reset as well as an external reset pin (RSTB) to start or restart operation using default configuration. An enable pin (EN) with power-down capability is also available.

The sensor is powered with a single 5V DC power supply through pins VDD and GND. Although the sensor contains three separate VDD pins, the sensor is supplied by a single 5V voltage source. It is recommended to supply the three VDD pins in a star connection with appropriate decoupling capacitors. Regarding the sensor grounds, all the GND pins are internally shorted. The GND pins redundancy is used for multiple bonds in order to reduce the total ground inductance. It is therefore recommended to connect all the GND pins to the ground.

10. Available Tools and Resources

The following tools and resources are available on the AXO[®] product page of our [website](#).

Item	Description
Documentation & technical notes	
	AXO215 - Flyer
	AXO215 - Datasheet
Mechanical tools	
	AXO215 - 3D model
Evaluation kit	
	AXO[®]-EVB3 – Evaluation board <i>Evaluation board for AXO215, compatible with Arduino M0</i>
	Tronics Evaluation Tool – Software
	AXO[®]-EVB3 – User manual
	Tronics Evaluation Kit – Quick Start Guide
	Tronics Evaluation Tool – Software User Manual
	Tronics Evaluation Tool – Installation Tutorial
	Tronics Evaluation Tool – Software Tutorial
	Tronics Evaluation Tool – Arduino Firmware