

THESE DRAWINGS ARE THE PROPERTY OF QUALTEK ELECTRONICS AND NOT TO BE REPRODUCED FOR OR COMMUNICATED TO A THIRD PARTY WITHOUT THE EXPRESS WRITTEN PERMISSION OF AN OFFICER OF QUALTEK ELECTRONICS.

REVISION			
REV.	DESCRIPTION	DATE	APPROVED

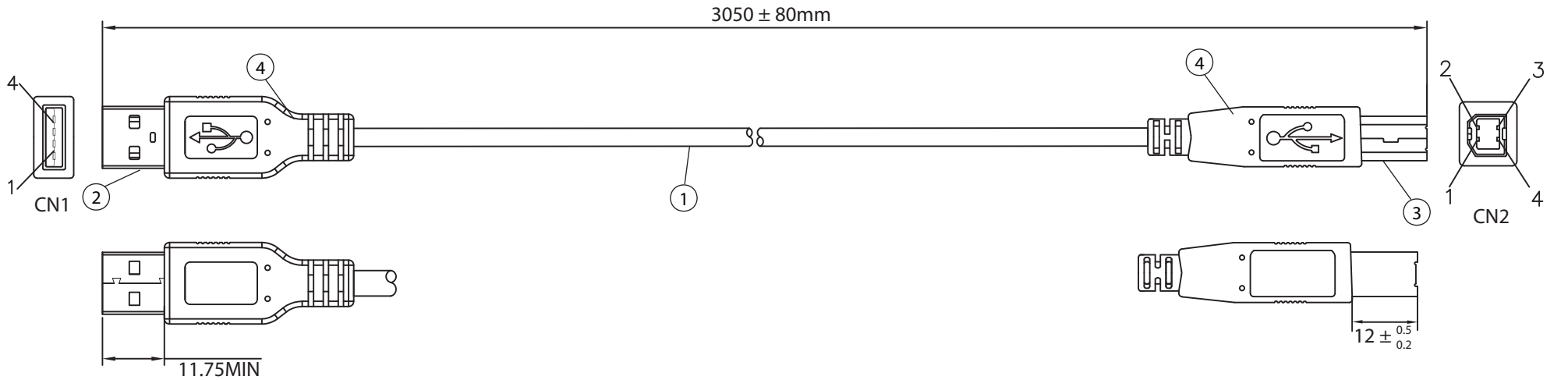

CONNECTION

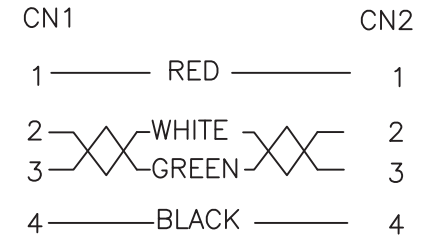

SHELL — BRAID&DRAIN — SHELL

NOTES:

- CABLE: UL2725 26/28AWG
28AWGx1PR+26AWGx2C+ AEB(AL) 65%
OUTER JACKET: WHITE, OD: 4.2 ± 0.2mm
- CONNECTOR: USB 2.0 A TYPE MALE
INSULATOR: WHITE PBT
PIN G/F
NICKEL PLATED SHELL
- CONNECTOR: USB 2.0 B TYPE MALE
INSULATOR: WHITE PBT
PIN G/F
NICKEL PLATED SHELL
- PVC MOLDED: COLOR 45P WHITE
- ELECTRICAL TEST:
<1>.100% OPEN SHORT & MISS WIRE TEST
<2>.INSULATION RESISTANCE: DC300V 10M ohm MIN.
<3>.CONDUCTOR RESISTANCE: 2 ohm MAX.
- PACKING: 1PC/POLYBAG W/ LABEL

CONTROLLED

Dim range (mm)	Tolerance +/- (mm)	Qualtek Electronics Corp. WCI DIVISION		
		Part Number: 3021063-10	RoHS Compliant	
0-1	0.15	Description: USB 4P(A)/M - USB 4P(B)/M		
1-6	0.20	UNIT: mm		
6-18	0.30			
18-50	0.50			
50-120	0.70	Drawn / Date	Checked / Date	Approved / Date
120-250	0.90	R. Nuti 09-25-17	09-25-17	LY / 09-25-17
250-500	1.20			